

KAMALA NEHRU COLLEGE

(University of Delhi)

NAAC Accredited with 'A' Grade

August Kranti Marg, New Delhi-110049

Phone : 011-26494881, Telefax : 011-26495964

e-mail : kamala.nehru_du@hotmail.com



कमला नेहरू कॉलेज

(दिल्ली विश्वविद्यालय)

रा.मू.एवं प्र.प. द्वारा 'ए' श्रेणी प्रत्यायित

अगस्त क्रांति मार्ग, नई दिल्ली-110049

दूरभाष : 011-26494881, टेलीफैक्स : 011-26495964

ई-मेल : kamala.nehru_du@hotmail.com

Criterion 5.3.3

Average number of sports and cultural events/competitions in which students of the Institution participated during last five years (organised by the institution/other institutions)

COPY OF CIRCULAR/BROCHURE

Answer to DVV Query

PRINCIPAL
KAMALA NEHRU COLLEGE
(University of Delhi)
August Kranti Marg
New Delhi-110049

KAMALA NEHRU COLLEGE

(University of Delhi)

NAAC Accredited with 'A' Grade

August Kranti Marg, New Delhi-110049

Phone : 011-26494881, Telefax : 011-26495964

e-mail : kamala.nehru_du@hotmail.com



कमला नेहरू कॉलेज

(दिल्ली विश्वविद्यालय)

रा.मू.एवं प्र.प. द्वारा 'ए' श्रेणी प्रत्यायित

अगस्त क्रांति मार्ग, नई दिल्ली-110049

दूरभाष : 011-26494881, टेलीफैक्स : 011-26495964

ई-मेल : kamala.nehru_du@hotmail.com



दिल्ली विश्वविद्यालय खेल परिषद्

Delhi University Sports Council

दिल्ली विश्वविद्यालय University of Delhi

DUSC/IC/2019-20/
07.02.2020

The Principal/OSD
Constituent College/Institute
University of Delhi
Delhi

Subject: Selection Trials for Delhi University Gymnastics (M&W) Team for All India Inter University Gymnastics (M&W) Tournament for the year 2019-20 regarding.

Dear Sir/Madam,

This is to inform you that the Selection Trials for Delhi University Gymnastics (M&W) Team for All India Inter University Gymnastics (M&W) Tournament for the year 2019-20 will be held on 17th February, 2020 from 08.30 am onwards at Gymnasium Hall, Sarvodaya Bal Vidyalaya, Block IV, Subhash Nagar, New Delhi-110027.

You are requested to send you outstanding players along with their College Identity Card, Eligibility Proforma and Team Manager for the Trials. The players shall report to Dr. Saryu Ruhella (9911109154), Convener, Gymnastics (M&W) Tournament Committee 2019-20.

Tournament Committee;

Dr. Saryu Ruhella (Convener)
Dr. Vivek Chaudhary
Dr. Simran Chakravarty
Dr. Anjum Padyal
Dr. Rekha Sharma
Dr. Anuj Chaudhary

Kamala Nehru College
Sri Aurobindo College (E)
IGIPSS
Deshbandhu College
Salyawati College
Aryabhata College

Sincerely yours,

(Anil Kumar Kalkal)

Director, Physical Education & Sports

KAMALA NEHRU COLLEGE

(University of Delhi)

NAAC Accredited with 'A' Grade

August Kranti Marg, New Delhi-110049

Phone : 011-26494881, Telefax : 011-26495964

e-mail : kamala.nehru_du@hotmail.com



कमला नेहरू कॉलेज

(दिल्ली विश्वविद्यालय)

रा.मू.एवं प्र.प. द्वारा 'ए' श्रेणी प्रत्यायित

अगस्त क्रांति मार्ग, नई दिल्ली-110049

दूरभाष : 011-26494881, टेलीफैक्स : 011-26495964

ई-मेल : kamala.nehru_du@hotmail.com

DELHI UNIVERSITY SPORTS COUNCIL

University of Delhi

DUSC/2018/19
Date: 27.01.2020

Delhi University Inter College Taekwondo (M&W) Championship 2019-20 (Men & Women)

- Date of Championship : 04th to 06th February, 2020
Venue : Multipurpose Hall, University of Delhi
Reporting Time : 09.00 A.M. daily (Team reporting late will not be entertained)
Weighting (M&W) : 04th February 2020 (between 09.00 to 11.00 am only)
- Important Documents : Eligibility Performa duly signed by the Competent Authority.
: Players must bring their College Identity Card failing which they will not be allowed to participate.
: Team Manager must be present at the time of Weight-in and Competition.
: Delhi University team will be selected on the basis of performance during Competition by the Selection Committee Constituted as per the constitution of DUSC.
: Players should bring their own Chest Guard, Head Guard and Other approved protective equipments.

Weight Categories (Men)

Under 54 kg
Under 58 kg
Under 63 kg
Under 68 kg
Under 74 kg
Under 80 kg
+80 kg
-87 kg

Weight Categories (Women)

Under 46 kg
Under 49 kg
Under 53 kg
Under 57 kg
Under 62 kg
Under 67 kg
+67 kg
+73 kg

The Competition shall be conducted on knock out-cum-single system and as per the AIU/Federation rules.

Tournament Committee:

Dr. Amita Rana (9811803652)
Dr. Pramod Sethi
Dr. Manoj Rathi
Dr. Pradeep Sharma
Dr. Surender Singh
Mr. Nannashish Prem Singh

Convenor Mirinda House
PGDAV (E)
Motilal Nehru College (E)
Ram Lal Anand
Keshav Mahavidhalya
Moti Lal Nehru College

Dr. Anil Kumar Kulkal
Director, Physical Education & Sports

KAMALA NEHRU COLLEGE

(University of Delhi)

NAAC Accredited with 'A' Grade

August Kranti Marg, New Delhi-110049

Phone : 011-26494881, Telefax : 011-26495964

e-mail : kamala.nehru_du@hotmail.com



कमला नेहरू कॉलेज

(दिल्ली विश्वविद्यालय)

रा.मू.एवं प्र.प. द्वारा 'ए' श्रेणी प्रत्यायित

अगस्त क्रांति मार्ग, नई दिल्ली-110049

दूरभाष : 011-26494881, टेलीफैक्स : 011-26495964

ई-मेल : kamala.nehru_du@hotmail.com

League Matches

Group-I	Timing	08.11.19	09.11.19	11.11.19
	10.00 am	B V/s E	B V/s F	E V/s F
	11.00 am	C V/s F	C V/s E	B V/s C
Group-II	Timing	A V/s H	A V/s G	G V/s H
	12.00 noon	A V/s H	A V/s G	G V/s H
	01.00 pm	D V/s G	D V/s H	A V/s D
13.11.19	10.00 am	Winner of Group-I V/s Runner of Group-II		
	11.30 am	Winner of Group-II V/s Runner of Group-I		
14.11.19	10.00 am	Thrd Place Match		
	11.30 am	Final Match		

Venue: Maitreyi College, University of Delhi.

Note:

- Convener should confirm the participation of Team before the Match. In case non-availability of Team, walkover may be awarded by the Convener to the reporting Team.
- Students should carry their College I-Cards and Eligibility Performa signed by the Head of the Institution / Competent Authority.
- Team should be accompanied by the Manager.
- Delhi University team will be selected by the Selection Committee constituted as per the constitution of DUSC.
- For Selection Trial, the Convener may be contacted for details.

Tournament Committee:

- | | | |
|------|--|---|
| i. | Dr. Shipra Verma (7042577899) Convener | Maitreyi College |
| ii. | Dr. M. Chkravorty | Ramjas College |
| iii. | Dr. Anju Luthra | Jesus & Mary College |
| iv. | Dr. Meenkashi Pahuja | Lady Shri Ram College |
| v. | Dr. Binla Pawar | Shaheed Raj Guru College Appl. Sciences |

Dr. Anil Kumar Kalkal
Director, Physical Education & Sports



University of Delhi

Fixture Inter College Basketball (Women) Tournament 2019-20

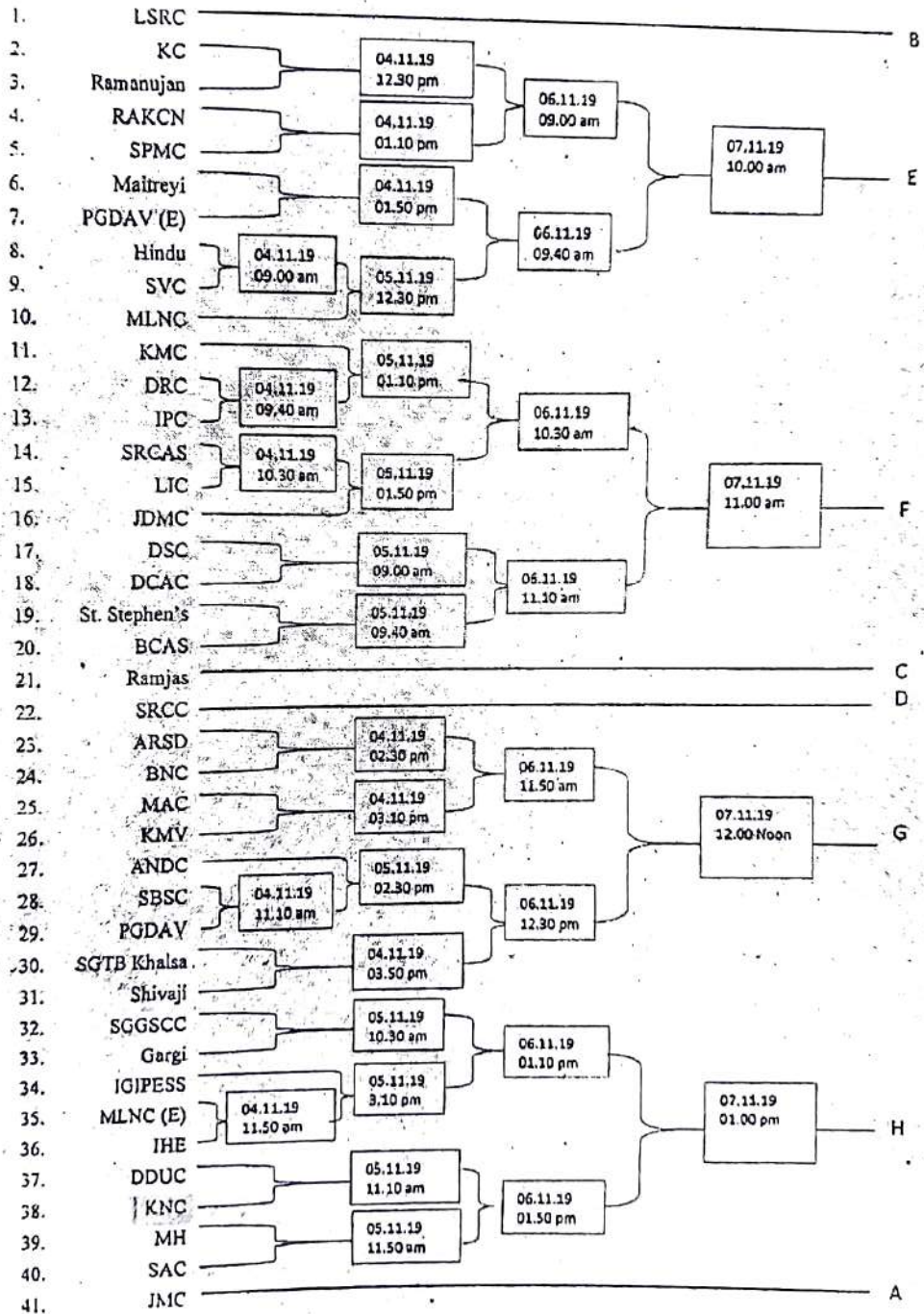

KAMALA NEHRU COLLEGE

(University of Delhi)

NAAC Accredited with 'A' Grade

August Kranti Marg, New Delhi-110049

Phone : 011-26494881, Telefax : 011-26495964

e-mail : kamala.nehru_du@hotmail.com



कमला नेहरू कॉलेज

(दिल्ली विश्वविद्यालय)

रा.मू.एवं प्र.प. द्वारा 'ए' श्रेणी प्रत्यायित

अगस्त क्रांति मार्ग, नई दिल्ली-110049

दूरभाष : 011-26494881, टेलीफैक्स : 011-26495964

ई-मेल : kamala.nehru_du@hotmail.com

League Matches

	<u>13.11.19</u>	<u>14.11.19</u>	<u>15.11.19</u>
01.00 pm	A Vs D	A Vs C	C Vs D
02.00 pm	B Vs C	B Vs D	A Vs B

Note:

- Convener should confirm the participation of Team before the Match. In case non-availability of Team, walkover may be awarded by the Convener to the reporting Team.
- Students should carry their College I-Cards and Eligibility Performa signed by the Head of the Institution / Competent Authority.
- Team should be accompanied by the Manager.
- Delhi University team will be selected by the Selection Committee constituted as per the constitution of DUSC
- For Selection Trial, the Convener may be contacted for details.

Venue: Daulat Ram College, University of Delhi.

Tournament Committee: -

Dr. Kavita Sharma (9540321833) (Convener)
Dr. Parmod C. Sharma
Dr. Meenakshi
Dr. Kavita Vats

Daulat Ram College
Kirori Mal College
IGIPSS
Shyama Prasad Mukherjee College

Dr. Anil Kumar Kalkal
Director, Physical Education & Sports



Delhi University Sports Council
University of Delhi

DUSC/IC(W)/2019/
28.10.2019

Fixture of Delhi University Inter College Kho-Kho (Women) Tournament 2019-20

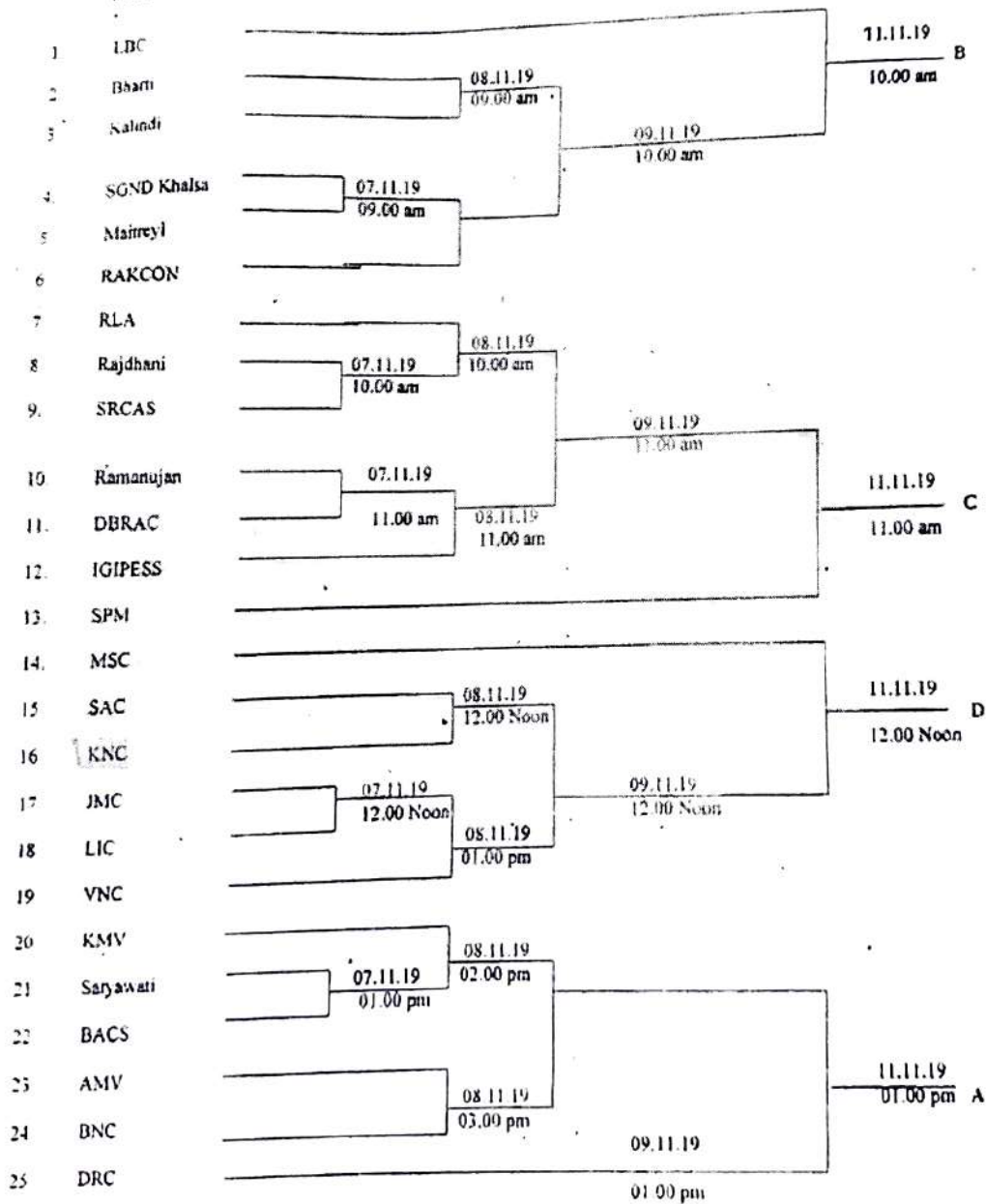



Delhi University Sports Council
University of Delhi

DUSC/IC(W)/2019/
28.10.2019

Fixture of Delhi University Inter College Cricket (Women) Tournament 2019-20

1	JMC				
2	Satyawati				13.11.19 B
3	Ramanujan		11.11.19 09.00 am		09.00 am
4	PGDAV				
5	Bharati		11.11.19 09.00 am		
6	BNC			11.11.19 09.00 am	13.11.19 C
7	LBC				09.00 am
8	KNC				
9	DSC				13.11.19 D
10	Maitreyi		11.11.19 09.00 am		09.00 am
11	SVC				
12	IGIPSS		11.11.19 09.00 am		13.11.19 A
13	Gargi				09.00 am

League Matches	14.11.19	15.11.19	16.11.19
09.00 am	A Vs D	A Vs C	C Vs D
09.00 am	B Vs C	B Vs D	A Vs B

Note:

- Convener will intimate the Venue of the Match to the participant team before the match.
- Convener should confirm the participation of Team before the Match. In case non-availability Team, walkover may be awarded by the Convener to the reporting Team.
- Students should carry their College I-Cards and Eligibility Performa signed by the Head of t Institution / Competent Authority.
- Team should be accompanied by the Manager.
- Delhi University team will be selected by the Selection Committee constituted as per t constitution of DUSC.
- For Selection Trial, the Convener may be contacted for details.

Tournament Committee: -

Dr. Sunita Arora (9999968377) (Convener)
Dr. Sheela K.S.
Dr. Kavita Sharma
Dr. Sweta Suri

Lakshmbai College
Gargi College
Daulat Ram College
Kamala Nehru College

Dr. Anil Kumar Kalkal
Director, Physical Education & Sports

KAMALA NEHRU COLLEGE

(University of Delhi)

NAAC Accredited with 'A' Grade

August Kranti Marg, New Delhi-110049

Phone : 011-26494881, Telefax : 011-26495964

e-mail : kamala.nehru_du@hotmail.com



कमला नेहरू कॉलेज

(दिल्ली विश्वविद्यालय)

रा.मू.एवं प्र.प. द्वारा 'ए' श्रेणी प्रत्यायित

अगस्त क्रांति मार्ग, नई दिल्ली-110049

दूरभाष : 011-26494881, टेलीफैक्स : 011-26495964

ई-मेल : kamala.nehru_du@hotmail.com

Delhi University Sports Council University of Delhi

Fixture of Delhi University Inter College Football (Women) Tournament 2019-20

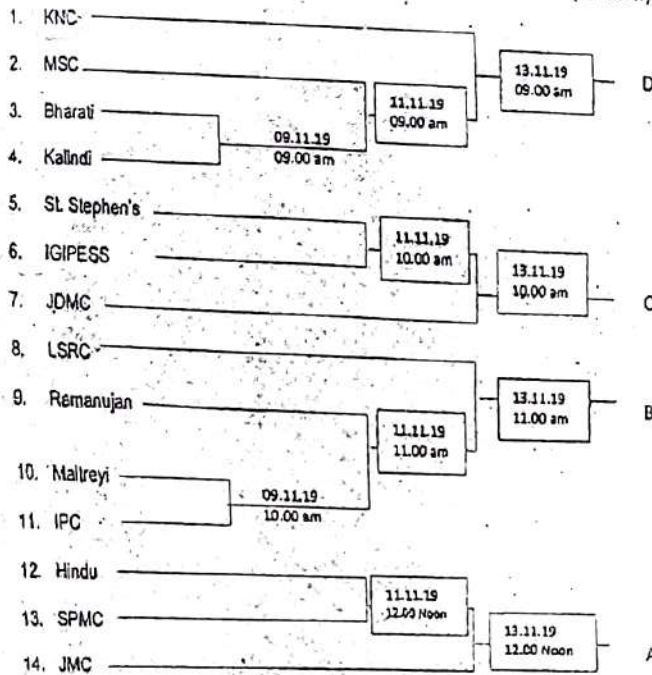

League Matches

	14.11.19	15.11.19	16.11.19
10:00 am	A.Vs D	A Vs C	C Vs D
12:30 pm	B.Vs C	B.Vs D	A Vs B

Note:

- Convener should confirm the participation of Team before the Match. In case non-availability of Team, walkover may be awarded to the Convener to the reporting Team.
- Students should carry their College I-Cards and Eligibility Performa signed by the Head of the Institution / Competent Authority.
- Team should be accompanied by the Manager.
- Delhi University team will be selected by the Selection Committee constituted as per the constitution of DUSC.
- For Selection Trials: The Convener may be contacted for details.

Venue: Jesus & Mary College, University of Delhi.

Tournament Committee:-

Dr. Anju Luthra (9873251901)

(Convener)

Dr. Saryu Ruhella

Dr. Abha Jain

Dr. Rakesh

Dr. Meenakshi Pahuja

Jesus & Mary College

Kamala Nehru College

Janki Devi Memorial College

Gargi College

Lady Shri Ram College

Dr. Anil Kumar Kalkal

Director, Physical Education & Sports

KAMALA NEHRU COLLEGE

(University of Delhi)

NAAC Accredited with 'A' Grade

August Kranti Marg, New Delhi-110049

Phone : 011-26494881, Telefax : 011-26495964

e-mail : kamala.nehru_du@hotmail.com



कमला नेहरू कॉलेज

(दिल्ली विश्वविद्यालय)

रा.मू.एवं प्र.प. द्वारा 'ए' श्रेणी प्रत्यायित

अगस्त क्रांति मार्ग, नई दिल्ली-110049

दूरभाष : 011-26494881, टेलीफैक्स : 011-26495964

ई-मेल : kamala.nehru_du@hotmail.com

Delhi University Sports Council University of Delhi, Delhi - 110007

Ref DUSC/2019-20/ 2771

Dated: 18-10-19

Delhi University Inter College Athletics (Men & Women) Championship 2019-20

- Date of Championship : 07th to 09th November, 2019
Venue of Championship : University Pologround, University of Delhi
- Schedule of Events : Track & Field Events at University Pologround from 07th November to 09th November, 2019 from 9.00am onwards.
Half Marathon at Rugby Stadium on 09th November, 2019 at 7.00am
Race Walk at University Pologround on 11th November, 2019 at 7.00am
The competition time to finish the race will be 1:30hrs. for Men & 1:45hrs for Women. The Manager should withdraw their athletes after the competition time.
- Last date of submission of Detailed Entry Form : 01st November, 2019 by 3.00pm
Delhi University Sports Council, Rugby Stadium, Delhi-110007.
- Distribution of Bib No. : 06th November, 2019 from 12.00noon to 4.00pm
Delhi University Sports Council, Rugby Stadium, Delhi-110007.
- Important Instruction : Detailed Entry Form & Eligibility Performa duly signed by the Competent Authority.
Athletes must bring their College Identity Card failing which they will not be allowed to participate.
Team Manager must be present at the time of Competition.
Athletes should report in proper Sports Kit.
Pole vaulter should bring their own poles for the Event.

Note:

- Each College can send Two Entries in One Individual Event.
- Each Athlete can participate in Two Individual Events & One Relay Race.
- Event will be considered as Final if there is no Heat conducted due to less number of participants in the Event.
- Selection Committee constituted by the DUSC will select the University Athletic Team for the 80th All India Inter University Championship 2019-20 on the basis of performance of the 6th place of the 79th All India Inter University Athletic Championship 2018-19 held at Mangalore University (Karnataka).

Tournament Committee

Dr. Surender Singh (9810323797)

Convener

Keshav Mahavidyalaya

Dr. Meera Sood

Vivekanand College

Dr. Amita Rana

Miranda House

Dr. Rakesh Gupta

IGIPSS

Dr. Narender Gaar

Sri Venkateswara College

Dr. Benu Gupta

Kirori Mal College

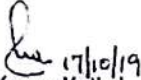
17/10/19
Dr. Anil Kumar Kalkal
Director, Physical Education

KAMALA NEHRU COLLEGE

(University of Delhi)

NAAC Accredited with 'A' Grade

August Kranti Marg, New Delhi-110049

Phone : 011-26494881, Telefax : 011-26495964

e-mail : kamala.nehru_du@hotmail.com



कमला नेहरू कॉलेज

(दिल्ली विश्वविद्यालय)

रा.मू.एवं प्र.प. द्वारा 'ए' श्रेणी प्रत्यायित

अगस्त क्रांति मार्ग, नई दिल्ली-110049

दूरभाष : 011-26494881, टेलीफैक्स : 011-26495964

ई-मेल : kamala.nehru_du@hotmail.com

State matches

OFFICE AT

DELHI UNIVERSITY SPORTS COUNCIL
Entry Form for University Inter College Tournament

Academic Year 2019-20

WOMEN ✓

- 1. ARCHERY
- 2. ATHLETICS ✓
- 3. BADMINTON
- 4. BASKETBALL ✓
- 5. BOXING
- 6. CHESS
- 7. CRICKET ✓
- 8. DIVING
- 9. FOOTBALL ✓
- 10. GYMNASTICS ✓
- 11. HAND BALL
- 12. HOCKEY
- 13. JUDO
- 14. KABADDI
- 15. KHO KHO ✓
- 16. NETBALL
- 17. SHOOTING ✓
- 18. SOFTBALL
- 19. SQUASH
- 20. SWIMMING
- 21. TABLE TENNIS
- 22. TAIKWONDO ✓
- 23. TENNIS
- 24. VOLLEYBALL
- 25. WEIGHT LIFTING
- 26. WRESTLING

Name of College/Institution KAMALA NEHRU COLLEGE

Name of the Bank & Branch

State Bank of India

UTR No

Cheque No - 548566

Date

23-8-19

Amount

Rs 1200/-

Dated: 19-8-19

Signature of the Director
With Seal of College/Institution

Signature of the Principal
कमला नेहरू कॉलेज / Kamala Nehru College
दिल्ली विश्वविद्यालय / University of Delhi
अगस्त क्रांति मार्ग / August Kranti Marg
नई दिल्ली-110049 / New Delhi-11

KAMALA NEHRU COLLEGE

(University of Delhi)

NAAC Accredited with 'A' Grade

August Kranti Marg, New Delhi-110049

Phone : 011-26494881, Telefax : 011-26495964

e-mail : kamala.nehru_du@hotmail.com



कमला नेहरू कॉलेज

(दिल्ली विश्वविद्यालय)

रा.मू.एवं प्र.प. द्वारा 'ए' श्रेणी प्रत्यायित

अगस्त क्रांति मार्ग, नई दिल्ली-110049

दूरभाष : 011-26494881, टेलीफैक्स : 011-26495964

ई-मेल : kamala.nehru_du@hotmail.com



दिल्ली विश्वविद्यालय खेल परिषद् Delhi University Sports Council दिल्ली विश्वविद्यालय University of Delhi

DUSC/Misc./2019
14.08.2019

The Principal/OSD
Constituent Colleges/Institutions
University of Delhi
Delhi

Subject: University Sports Activities for the Academic Year 2019-2020-reg.

Dear Colleague,

Greetings from the Sports Council Office 2019-2020.

We are about to begin the programme of Sports for the students of Undergraduate and Postgraduate courses for the Academic Year 2019-2020.

With the cardinal aim for promoting national integration, communal harmony and sporting spirit, we are confident that continuation of well structured sports programme would offer the much needed encouragement to students to strive for their excellence in Sporting Arena and thereby enhancing their skills for aesthetic appreciation.

In this context, your College/Institution is requested to send the Entries of Game/Sport on the prescribed Entry Format (Men & Women separately) duly signed by the Principal/OSD of the College/Institution to the office of the Director, Delhi University Sports Council, University Sports Complex, University of Delhi, Delhi-110007 latest by Friday, 23rd August 2019.

It is pertinent to mention here that the prescribed Entry Fee is Rs.150/- per Game/Sport (Men and Women separately) which may be submitted through NEFT/RTGS in "University General Fund A/c No. 10851298934" State Bank of India, Delhi University Branch, IFSC Code SBIN001067". The details of the NEFT/RTGS payment should be mentioned on the prescribed Entry Format.

You are also requested to send your proposal of Game/Sport for the conduct of Delhi University Inter College Tournament. The proposal/s may be sent to the Office of the Director, Delhi University Sports Council, University Sports Complex, University of Delhi, Delhi-110007 latest by Friday 23rd August, 2019.

The General Body Meeting of the DUSC and the Meeting for Drawing of Fixture(s) for Delhi University Inter College Tournament are tentatively scheduled to be held in the first week of September 2019.

Looking forward for your cooperation and earliest response as always.

Encl.: As above.

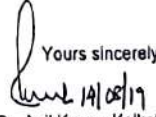
Yours sincerely,

(Dr. Anil Kumar Kalkal)
Director, Physical Education

KAMALA NEHRU COLLEGE
(University of Delhi)
NAAC Accredited with 'A' Grade
August Kranti Marg, New Delhi – 110049
Phone: 011-26494881, Telefax: 011-26495964
E-mail: kamla.nehru_du@hotmail.com



ESTD. 1964

कमला नेहरू कॉलेज
(दिल्ली विश्वविद्यालय)
रा. मू. एवं प्र. प. द्वारा 'ए' श्रेणी प्रत्यायित
अगस्त क्रांति मार्ग, नई दिल्ली – 110049
दूरभाष: 011-26494881, टेलीफैक्स: 011- 26495964
ई-मेल: kamla.nehru_du@hotmail.com

CULTURAL EVENTS: BROCHURE/CIRCULAR

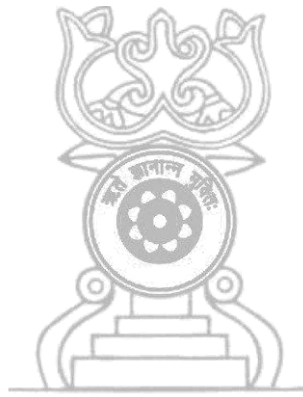

Kamala Nehru College
Estd. 1964



KAMALA NEHRU COLLEGE
(University of Delhi)
NAAC Accredited with 'A' Grade
August Kranti Marg, New Delhi – 110049
Phone: 011-26494881, Telefax: 011-26495964
E-mail: kamla.nehru_du@hotmail.com



ESTD. 1964

कमला नेहरू कॉलेज
(दिल्ली विश्वविद्यालय)
रा. मू. एवं प्र. प. द्वारा 'ए' श्रेणी प्रत्यायित
अगस्त क्रांति मार्ग, नई दिल्ली – 110049
दूरभाष: 011-26494881, टेलीफैक्स: 011- 26495964
ई-मेल: kamla.nehru_du@hotmail.com

I- Cultural Participation posters outside college



Nrityam

Classical Dance Society Of Vivekananda College
PRESENTS

'ABHYUDAYA'

Spreading Happiness and Prosperity
Semi classical dance competition
UNDER
"AZADI KA AMRUT MAHOTSAV"

Join us to elebrate through movement and expression

DATE: 22nd October 2021
TIME: 3pm
VENUE: Google Meet

Register Now
<https://forms.gle/m8dpmSWk3WfzLX2V6>

LAST DATE TO REGISTER: 20th October 2021 (12 Noon)

Dr Hina Nandrajog Officiating Principal	For further queries contact Isha Bhatia: 9911491567 President
Dr Sheetal Teacher Convenor	Ishika Singh: 7982493895



Kamala Nehru College
Estd. 1964



PRINCIPAL
KAMALA NEHRU COLLEGE
(University of Delhi)
August Kranti Marg
New Delhi - 110049

KAMALA NEHRU COLLEGE
(University of Delhi)
NAAC Accredited with 'A' Grade
August Kranti Marg, New Delhi – 110049
Phone: 011-26494881, Telefax: 011-26495964
E-mail: kamla.nehru_du@hotmail.com



ESTD. 1964

कमला नेहरू कॉलेज
(दिल्ली विश्वविद्यालय)
रा. मू. एवं प्र. प. द्वारा 'ए' श्रेणी प्रत्यायित
अगस्त क्रांति मार्ग, नई दिल्ली – 110049
दूरभाष: 011-26494881, टेलीफैक्स: 011- 26495964
ई-मेल: kamla.nehru_du@hotmail.com

**annhad**
THE INDIAN DANCE SOCIETY
DAULAT RAM COLLEGE

presents

RAAS 7.0

YOGEYA
Solo Classical Dance Competition





Kamala Nehru College
Estd. 1964

PRINCIPAL
KAMALA NEHRU COLLEGE
(University of Delhi)
August Kranti Marg
New Delhi-110049



जयतु संस्कृतम्



जयतु भारतम्



संस्कृतभारती, देहली

प्रान्तसम्मेलनम्



चैत्रमासः, कृष्णपक्षः - ४, ५, ६ मार्च (विक्रमसंवत् - २०७८)

स्थानम् :

श्रीजयराम-आश्रमः, हरिनगरम्, आश्रम चौक,
मथुरा रोड, नवदेहली



KAMALA NEHRU COLLEGE
(University of Delhi)
NAAC Accredited with 'A' Grade
August Kranti Marg, New Delhi – 110049
Phone: 011-26494881, Telefax: 011-26495964
E-mail: kamla.nehru_du@hotmail.com



ESTD. 1964

कमला नेहरू कॉलेज
(दिल्ली विश्वविद्यालय)
रा. मू. एवं प्र. प. द्वारा 'ए' श्रेणी प्रत्यायित
अगस्त क्रांति मार्ग, नई दिल्ली – 110049
दूरभाष: 011-26494881, टेलीफैक्स: 011- 26495964
ई-मेल: kamla.nehru_du@hotmail.com



**LOVELY
PROFESSIONAL
UNIVERSITY**



Department of
Cultural Affairs

राधाक

लाहोतइव

29 November 2020

राधाक

लाहोतइव



Dr. Mayura
Pandit Khataukar



Preeti Sharma



Shambhawi Tiwari



Shruti Kotnala



Nayanika Gangani

29th November 2020

 **LIVE**

Division of Student Welfare
L-1111



Kamala Nehru College
Estd. 1964

PRINCIPAL
KAMALA NEHRU COLLEGE
(University of Delhi)
August Kranti Marg
New Delhi-110049

KAMALA NEHRU COLLEGE
(University of Delhi)
NAAC Accredited with 'A' Grade
August Kranti Marg, New Delhi – 110049
Phone: 011-26494881, Telefax: 011-26495964
E-mail: kamla.nehru_du@hotmail.com



ESTD. 1964

कमला नेहरू कॉलेज
(दिल्ली विश्वविद्यालय)
रा. मू. एवं प्र. प. द्वारा 'ए' श्रेणी प्रत्यापित
अगस्त क्रांति मार्ग, नई दिल्ली – 110049
दूरभाष: 011-26494881, टेलीफैक्स: 011- 26495964
ई-मेल: kamla.nehru_du@hotmail.com

Watch us on  **LIVE** of
**Gurukul Music and Dance
Academy**

GURU HARISH GANGANI
Kathak Exponent



16th July, 2020 | 7:00 p.m. IST

NAYANIKA GANGANI
Budding Performer



FOR FURTHER PERFORMANCES :
APPLY THROUGH THE ATTACHED FORM

SIDDHARTH DALBEHERA
Flutist



In support of
our vision to
HELP ART GROW,

please make voluntary contributions

through  or  on

+91-9873425900

Also find us on Instagram: @deepak.aurora

For queries:

+91-9873425900

+91-9810155800

Email: s.galhotra@yahoo.co.in | ms.arundhati.mitra@gmail.com



Kamala Nehru College
Estd. 1964

PRINCIPAL
KAMALA NEHRU COLLEGE
(University of Delhi)
August Kranti Marg
New Delhi-110049

KAMALA NEHRU COLLEGE
(University of Delhi)
NAAC Accredited with 'A' Grade
August Kranti Marg, New Delhi - 110049
Phone: 011-26494881, Telefax: 011-26495964
E-mail: kamla.nehru_du@hotmail.com



ESTD. 1964

कमला नेहरू कॉलेज
(दिल्ली विश्वविद्यालय)
रा. मू. एवं प्र. प. द्वारा 'ए' श्रेणी प्रत्यायित
अगस्त क्रांति मार्ग, नई दिल्ली - 110049
दूरभाष: 011-26494881, टेलीफैक्स: 011- 26495964
ई-मेल: kamla.nehru_du@hotmail.com

Ministry of Culture (Govt. of India)

&

Pt. Bijju Maharaj ji's

KALASHRAM

Presents

23rd Vasantotsava 2021

through online presentations of dance & music

20th Feb - 9:00 PM IST

Anirban Bhattacharyya
&
Somdatta Basu

Pt. Deepak Maharaj

Kadamb Group

Harish Gangani
&
Nayanika Gangani

View on: Kalashram Gulmoharpark  YouTube Channel



Kamala Nehru College
Estd. 1964

PRINCIPAL
KAMALA NEHRU COLLEGE
(University of Delhi)
August Kranti Marg
New Delhi-110049



Ministry of Culture
Government of India

संगीत
नाटक
अकादेमी



Sangeet
Natak
Akademi



कथक केन्द्र, नई दिल्ली

Kathak Kendra, New Delhi

संगीत नाटक अकादेमी की घटक इकाई
(संगीत, नृत्य एवं नाटक की राष्ट्रीय अकादेमी, नई दिल्ली)
(संस्कृति मंत्रालय, भारत सरकार की स्वायत्त संस्था)

A Constituent Unit of Sangeet Natak Akademi
(National Academy of Music, Dance and Drama, New Delhi)
(An Autonomous Body of Ministry of Culture, Government of India)

Celebrating 75 Years of Independence

SWADHEENTA KE RANG PHALGUN KE SANG

19th - 25th March 2021

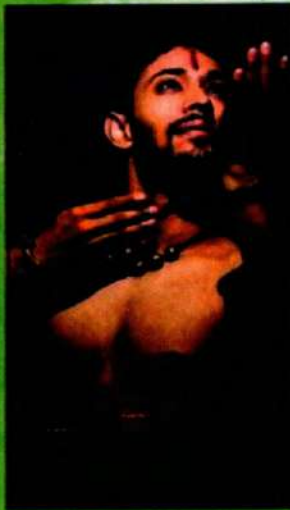

Avinav Mukherjee



Devendra Manglamukhi



Harish Gangani &
Nayanika Gangani



Purna Shrimali

19th March 2021, 2:00 P. M. onwards

**Swami Vivekanand Auditorium, Kathak Kendra
(National Institute of Kathak Dance)
2, San Martin Marg, Chanakyapuri, New Delhi**

<https://www.facebook.com/sangeetnatak/>

<https://www.youtube.com/sangeetnatak/>

KAMALA NEHRU COLLEGE
 (University of Delhi)
 NAAC Accredited with 'A' Grade
 August Kranti Marg, New Delhi – 110049
 Phone: 011-26494881, Telefax: 011-26495964
 E-mail: kamla.nehru_du@hotmail.com



ESTD. 1964

कमला नेहरू कॉलेज
 (दिल्ली विश्वविद्यालय)
 रा. मू. एवं प्र. प. द्वारा 'ए' श्रेणी प्रत्यायित
 अगस्त क्रांति मार्ग, नई दिल्ली – 110049
 दूरभाष: 011-26494881, टेलीफैक्स: 011- 26495964
 ई-मेल: kamla.nehru_du@hotmail.com

अगस्त
07-13
सांठ 6 से 7

कला भारती
अंतराष्ट्रीय
कथक महोत्सव-2

LIVE

श्रीमती रुचि बल्लूजी
कथक शिक्षा प्रमुख, उत्कलकर भारतीय मेलस प्रायोजक

कला भारती
international

Kathak
MAHOTSAV-2

10th August 2020

6pm to 8:30
6:30 to 7pm

श्रीमती रुचि बल्लूजी
कथक शिक्षा प्रमुख, उत्कलकर भारतीय मेलस प्रायोजक

अंतराष्ट्रीय कथक महोत्सव-2

10th August 2020

श्रीमती रुचि बल्लूजी
कथक शिक्षा प्रमुख, उत्कलकर भारतीय मेलस प्रायोजक

श्रीमती रुचि बल्लूजी
कथक शिक्षा प्रमुख, उत्कलकर भारतीय मेलस प्रायोजक

श्री प्रदीप कुमार
उत्कलकर भारतीय मेलस प्रायोजक

श्री अनिल कुमार
उत्कलकर भारतीय मेलस प्रायोजक

श्री आनंद कुमार
उत्कलकर भारतीय मेलस प्रायोजक



Blakur
 PRINCIPAL
 KAMALA NEHRU COLLEGE
 (University of Delhi)
 August Kranti Marg
 New Delhi-110049

KAMALA NEHRU COLLEGE
(University of Delhi)
NAAC Accredited with 'A' Grade
August Kranti Marg, New Delhi - 110049
Phone: 011-26494881, Telefax: 011-26495964
E-mail: kamla.nehru_du@hotmail.com



ESTD. 1964

कमला नेहरू कॉलेज
(दिल्ली विश्वविद्यालय)
रा. मू. एवं प्र. प. द्वारा 'ए' श्रेणी प्रत्यायित
अगस्त क्रांति मार्ग, नई दिल्ली - 110049
दूरभाष: 011-26494881, टेलीफैक्स: 011- 26495964
ई-मेल: kamla.nehru_du@hotmail.com



Naad Institute Of Music Society Lucknow

Facebook Live Session 53

Wednesday 2 December 2020

Time : - 7.00 PM



Nayanika Gangani

Disciple Of
Shri Harish Gangani

Arun Mishra

mob no - 9936021402

8090010451



Watch On  LIVE

www.naadinstituteofmusicsociety@gmail.com



Kamala Nehru College
Estd. 1964

PRINCIPAL
KAMALA NEHRU COLLEGE
(University of Delhi)
August Kranti Marg
New Delhi-110049

KAMALA NEHRU COLLEGE
(University of Delhi)
NAAC Accredited with 'A' Grade
August Kranti Marg, New Delhi – 110049
Phone: 011-26494881, Telefax: 011-26495964
E-mail: kamla.nehru_du@hotmail.com



ESTD: 1964

कमला नेहरू कॉलेज
(दिल्ली विश्वविद्यालय)
रा. सू. एवं प्र. प. द्वारा 'ए' श्रेणी प्रत्यायित
अगस्त क्रांति मार्ग, नई दिल्ली – 110049
दूरभाष: 011-26494881, टेलीफैक्स: 011- 26495964
ई-मेल: kamla.nehru_du@hotmail.com

05-09-2020

 PRESENTS

"SHIKSHAK SAMMAN SAMAROH"

**COMING LIVE AT
07:30PM(IST)**

NAYANIKA GANGANI & SHRUTI KOTNALA
DISCIPLES OF GURU HARISH GANGANI JI
FROM DELHI

**FOR MORE INFO:
CONTACT: 9646539770
8740018770
@ seemrit87@gmail.com**

 **PAGE EICD2020**

**EICD PROJECT FOUNDER & DIRECTOR
SEEMRIT KAUR KHOSLA**

Kamala Nehru College
Estd. 1964

PRINCIPAL
KAMALA NEHRU COLLEGE
(University of Delhi)
August Kranti Marg
New Delhi 110049





PURVAI SANSKRETIKALA VIKASH KENDRA
presents
Sri Chaitanya **Purvai**
Manmohanaa

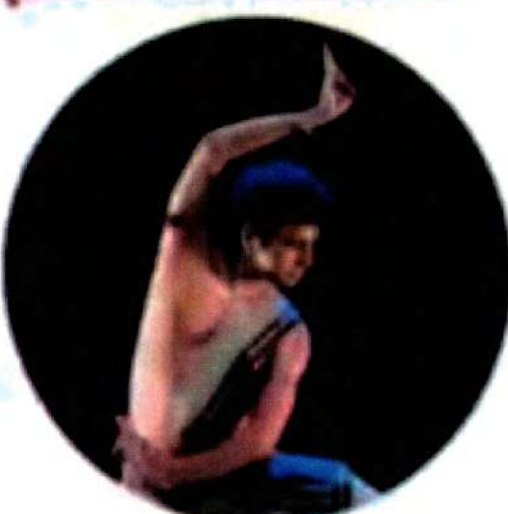

Arnob Bandyopadhyay
Odissi Exponent, Kolkata
DISCIPLE OF PADMABHUSHAN LT
GURU KELUCHARAN MOHAPATRA & GURU SATYKANT MOHAPATRA



Nilay Mandal
Bharatnatyaman, Kolkata
DISCIPLE OF SH. ANAND DEV MANDAL
& PURNABHUSHAN GURU SUREJA SURESHKANTHAN



Our Talents
Date: 1st July 2020 Time: 7:30pm
NANDINI CHAUDHRY MOHANTY

Nayanika Gangani
Kathak, New Delhi
DISCIPLE & DAUGHTER OF GURU RAJESH GANGANI

Contact : Smt Nandini Chaudhry Mohanty
9123785464 (Call), 9091797877 (WhatsApp)



KAMALA NEHRU COLLEGE
(University of Delhi)
NAAC Accredited with 'A' Grade
August Kranti Marg, New Delhi – 110049
Phone: 011-26494881, Telefax: 011-26495964
E-mail: kamla.nehru_du@hotmail.com



ESTD. 1964

कमला नेहरू कॉलेज
(दिल्ली विश्वविद्यालय)
रा. मू. एवं प्र. प. द्वारा 'ए' श्रेणी प्रत्यायित
अगस्त क्रांति मार्ग, नई दिल्ली – 110049
दूरभाष: 011-26494881, टेलीफैक्स: 011- 26495964
ई-मेल: kamla.nehru_du@hotmail.com



ICCR GUJARAT

Horizon Series Programme

Day:- 09



वसंत उत्सव

Date:- 09-02-2021

Kathak recital by
Nayanika Gangani

Disciple of Guru Harish Gangani

Join us through facebook live

 <https://www.facebook.com/ICCRGUJARAT> 

Time:- 07:30 pm IST



Connect with us  @ICCR_GUJARAT  @ICCRGUJARAT  @ICCRGUJARAT  ICCRGUJARAT



Kamala Nehru College
Estd. 1964

PRINCIPAL
KAMALA NEHRU COLLEGE
(University of Delhi)
August Kranti Marg
New Delhi-110049

KAMALA NEHRU COLLEGE
(University of Delhi)
NAAC Accredited with 'A' Grade
August Kranti Marg, New Delhi – 110049
Phone: 011-26494881, Telefax: 011-26495964
E-mail: kamla.nehru_du@hotmail.com



ESTD. 1964

कमला नेहरू कॉलेज
(दिल्ली विश्वविद्यालय)
रा. मू. एवं प्र. प. द्वारा 'ए' श्रेणी प्रत्यापित
अगस्त क्रांति मार्ग, नई दिल्ली – 110049
दूरभाष: 011-26494881, टेलीफैक्स: 011- 26495964
ई-मेल: kamla.nehru_du@hotmail.com



SONAD VENU PRESENTS

ताल VILAAS

IN THE MEMORY OF KATHAK MAESTRO
LATE PT. KUNDAN LAL GANGANI

23 JULY, 2020
6:30P.M. IST



**NATALIYA
KULAZHNA
(SITAR)**



**NAYANIKA
GANGANI**



**SIYA
MARWAH**

CATCH US  **LIVE**
OF HARISH GANGANI

PRINCIPAL
KAMALA NEHRU COLLEGE
(University of Delhi)
August Kranti Marg
New Delhi-110049

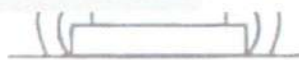
Kamala Nehru College
Estd. 1964

KAMALA NEHRU COLLEGE
(University of Delhi)
NAAC Accredited with 'A' Grade
August Kranti Marg, New Delhi - 110049
Phone: 011-26494881, Telefax: 011-26495964
E-mail: kamla.nehru_du@hotmail.com



ESTD. 1964

कमला नेहरू कॉलेज
(दिल्ली विश्वविद्यालय)
रा. मू. एवं प्र. प. द्वारा 'ए' श्रेणी प्रत्यापित
अगस्त क्रांति मार्ग, नई दिल्ली - 110049
दूरभाष: 011-26494881, टेलीफैक्स: 011- 26495964
ई-मेल: kamla.nehru_du@hotmail.com

Agrawal Educational Cultural and Welfare Society
Presents

NRITYA PRAVAAH

Live on Facebook

on July 11
at 6:00pm



Shri Harish Jangani
(Accompanying
On Tabla)



Nayanika Jangani
(Daughter and Disciple
of Shri Harish Jangani)



Gauravi Gupta

Regards
Dr. Swati Agarwal
Contact- 9414031122

Kamala Nehru College
Estd. 1964

PRINCIPAL
KAMALA NEHRU COLLEGE
(University of Delhi)
August Kranti Marg
New Delhi-110049

KAMALA NEHRU COLLEGE
(University of Delhi)
NAAC Accredited with 'A' Grade
August Kranti Marg, New Delhi - 110049
Phone: 011-26494881, Telefax: 011-26495964
E-mail: kamla.nehru_du@hotmail.com



कमला नेहरू कॉलेज
(दिल्ली विश्वविद्यालय)
रा. मू. एवं प्र. प. द्वारा 'ए' श्रेणी प्रत्यायित
अगस्त क्रांति मार्ग, नई दिल्ली - 110049
दूरभाष: 011-26494881, टेलीफैक्स: 011- 26495964
ई-मेल: kamla.nehru_du@hotmail.com

GLITZ FASHION SOCIETY

ESTD. 1964

Nakshatra The Fashion Society
Hindu College, University of Delhi

In association with

YOURSHELL™ & ORIGINE

presents

PANACHE'18

Beauty Partner

CLAMVEDA

Prizes worth Rs. 3,73,000/- to be won.

14th March, 2018 | 1 PM | Auditorium | +91-9650990053



Kamala Nehru College
Estd. 1964

B. Shalini
PRINCIPAL
KAMALA NEHRU COLLEGE
(University of Delhi)
August Kranti Marg
New Delhi-110049

KAMALA NEHRU COLLEGE
(University of Delhi)
NAAC Accredited with 'A' Grade
August Kranti Marg, New Delhi – 110049
Phone: 011-26494881, Telefax: 011-26495964
E-mail: kamla.nehru_du@hotmail.com



ESTD. 1964

कमला नेहरू कॉलेज
(दिल्ली विश्वविद्यालय)
रा. मू. एवं प्र. प. द्वारा 'ए' श्रेणी प्रत्यायित
अगस्त क्रांति मार्ग, नई दिल्ली – 110049
दूरभाष: 011-26494881, टेलीफैक्स: 011- 26495964
ई-मेल: kamla.nehru_du@hotmail.com

REVERIE 2018

Powered By 
LIKE

Opens Its Registrations For Society Events

29 - 31 JANUARY 2018

**FOR MORE DETAILS
KINDLY REFER TO THE CAPTION**



#Reverie2018



Kamala Nehru College
Estd. 1964

PRINCIPAL
KAMALA NEHRU COLLEGE
(University of Delhi)
August Kranti Marg
New Delhi-110049

KAMALA NEHRU COLLEGE
(University of Delhi)
NAAC Accredited with 'A' Grade
August Kranti Marg, New Delhi – 110049
Phone: 011-26494881, Telefax: 011-26495964
E-mail: kamla.nehru_du@hotmail.com



ESTD. 1964

कमला नेहरू कॉलेज
(दिल्ली विश्वविद्यालय)
रा. मू. एवं प्र. प. द्वारा 'ए' श्रेणी प्रत्यापित
अगस्त क्रांति मार्ग, नई दिल्ली – 110049
दूरभाष: 011-26494881, टेलीफैक्स: 011- 26495964
ई-मेल: kamla.nehru_du@hotmail.com



STUDENTS' UNION, GARGI COLLEGE

REVERIE 2020



FASHION WALK

DATE: 6TH FEBRUARY VENUE: MAIN STAGE TIME: 3:30 PM-5:30 PM

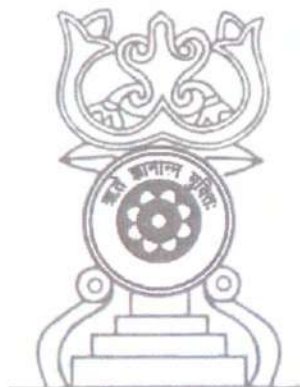

Kamala Nehru College
Estd. 1964

[Signature]
PRINCIPAL
KAMALA NEHRU COLLEGE
(University of Delhi)
August Kranti Marg
New Delhi-110049

KAMALA NEHRU COLLEGE
(University of Delhi)
NAAC Accredited with 'A' Grade
August Kranti Marg, New Delhi - 110049
Phone: 011-26494881, Telefax: 011-26495964
E-mail: kamla.nehru_du@hotmail.com





ESTD. 1964



कमला नेहरू कॉलेज
(दिल्ली विश्वविद्यालय)
रा. मू. एवं प्र. प. द्वारा 'ए' श्रेणी प्रत्यायित
अगस्त क्रांति मार्ग, नई दिल्ली - 110049
दूरभाष: 011-26494881, टेलीफैक्स: 011- 26495964
ई-मेल: kamla.nehru_du@hotmail.com

GLITZ FASHION SOCIETY
Presents
LA VOGUE '19
14TH MARCH 2019
12:30PM ONWARDS
VENUE: AUDITORIUM



CLOTHING BY: **STYLED BY:** **GIFTING BY:**

MAKEUP BY: **COSMETICS BY:** **EDUCATION BY:**

MEDIA COVERAGE BY: **HYGIENE CARE BY:**

CASH PRIZES WORTH
RS 20,000
AND AMAZING GIFT
HAMPERS !!

Kamala Nehru College
Estd. 1964

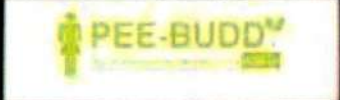
PRINCIPAL
KAMALA NEHRU COLLEGE
(University of Delhi)
August Kranti Marg
New Delhi-110049



ESTD. 1964

S. No.	Society	Event	Event Description	Venue	Time
1	Euphony	Acapella	Western Group Choir	Auditorium	9-11:30
2	Sanskrit	Sanskrit gayan	Singing	LT-1	9:30-12:30
3	Hues	Rangdaari	Art Marathon	Science Quad	9:30-2:30 pm
4	Sanskrit	Sanskrit gayan	Singing	LT-1	9:30-12:30
5	Euphony	Solo	Western Solo	Seminar Hall	12-2 pm
6	Arzz	Band Performance	Band Performance	Main stage	12-2:30 pm
7	Enliven	Zenith	Western Group	Auditorium	12-4 pm
8	Sanskrit	Bhashan	Debate	LT-1	12:30-4pm
9	Union	Treasure Hunt	Game	Ground	1:30-2:30 pm
10	Euphony	Duet	Western Duet	Seminar Hall	2:30-5 pm
11	Union	Fashion Show	Fashion Show & Surprise visit RJ Rahul Makin	Main Stage	3-4pm
12	Union	Star Night	Music	Main Stage	5:30 pm onwards



Kamala Nehru College
Estd. 1964

PRINCIPAL
KAMALA NEHRU COLLEGE
(University of Delhi)
August Kranti Marg
New Delhi-110049



ENIGMA WESTERN DANCE ESTD. 1964

TEMPEST 2018
 FUTURE OF FUN
20 FEBRUARY

DAY 1

SOCIETY	VENUE	TIME
• ADWITYA (Fine Arts Society)	SAC	9:30 am- 4:30pm
• MRIDANG (Indian Dance Society)	AUDITORIUM	9:30 am- 3:30pm
• LAKSHITA	ROOM NO.117	9:30 am- 11:30am
• GANDHI STUDY CIRCLE	ROOM NO. 119	10:00 am- 4:00pm
• JIGYASA (Quiz Society)	ROOM NO.145	9:30 am- 6:30pm
• GEETANJALI (Indian Music Society)	HERITAGE HALL	9:30 am- 5:30pm
• ORPHEUS (Western Music Society)	SEMINAR HALL	9:30 am- 2:30pm
• Women Development Cell	ROOM NO.305	10:00 am- 2:00pm
• ORPHEUS: BATTLE OF BANDS	OUTER STAGE	1:00 pm- 4:00pm
• BAND NIGHT	OUTER STAGE	5:00 pm- 7:0pm

TEMPEST 2018
 FUTURE OF FUN
21 FEBRUARY

DAY 2

SOCIETY	VENUE	TIME
• ADWITYA (Fine Arts Society)	SAC	9:30 am- 4:30pm
• JIGYASA (Quiz Society)	ROOM NO. 145	9:30 am- 6:30pm 1:00 pm- 2:30pm
• KBC		
• HINDI DEBATE	SEMINAR HALL	10:00 am- 6:00pm
• MH VATAVARAN	ROOM NO. 151	11:00 am- 2:00pm
• ENGLISH DEBATE	ROOM NO.248	9:30 am- 3:30pm
• EUPHONIC YOGA	AUDITORIUM	10:30 am- 12:30pm
• ARIELS (English Dramatics Society)	AUDITORIUM	1:00 pm- 4:00pm
• DJ NIGHT	OUTER STAGE	5:00 pm- 7:00pm

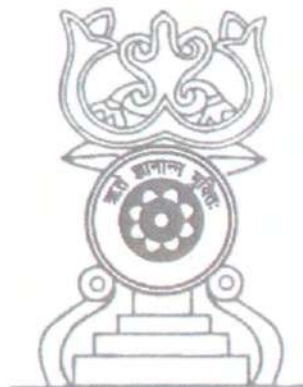

Kamala Nehru College
 Estd. 1964

 PRINCIPAL
 KAMALA NEHRU COLLEGE
 (University of Delhi)
 August Kranti Marg
 New Delhi-110049



Janki Devi Memorial College

(University of Delhi)

SYMPHONY 2019

8th, 9th & 10th January, 2019

Day-1 Tuesday-8th Jan

Inauguration
10:00a.m. (Auditorium)

Snap Stories - Photo Exhibition
10:00a.m. (lawn beside Principal's office & Rose Garden)

Business Battle
11:30a.m. (Room No. 15)

Samsrishti-Sanskrit Recitation
11:30a.m. (Room No. 16)

Your Quote Open Mic JDMC 2.0
12:00p.m. (Room No. 66)

Munadi (Street Play Competition) Drama Society "Anubhuti"
12:00p.m. (Hockey Field)

Face Painting
12:00p.m. (Room No. 17)

Puzzle Over: A Game for Crossword Puzzlers
12:00p.m. (Library)

Nandita Rajguru Memorial Debate
12:00p.m. (Seminar Room)

Abhivyakti - Hindi Debate
12:00p.m. (Room 12)

Samsrishti-Sanskrit Quiz
1:00p.m. (Room No. 16)

Day-2 Wednesday-9th Jan

Jabberwocky-Turncoat Debate (English)
9:30a.m. (Library)

Q & A-The Quiz Show
10:00a.m. (Seminar Room)

Lumiere : Film and Photography Competition
10:00a.m. (The lawn beside the office)

Jhankaar-Folk Dance Competition
10:00a.m. (Auditorium)

Paper Mania (Fun with Paper)
10:30a.m. (Room No. 14)

Solo Singing & Instrumental for Students with Disabilities
11:00a.m. (Music Room)

Sahityaki-Hindi Quiz
12:00p.m. (Room No. 12)

Jingle Writing Competition (Bilingual)
12:00p.m. (Room No. 13)

Rudimentary-Siam Poetry Competition
12:00p.m. (Girls Common Room)

Footloose - Western Group Dance Competition
12:00p.m. (Auditorium)

Ad-Mad
12:30p.m. (Room No. 16)

Day-3 Thursday-10th Jan

Aradhi-Indian Classical Dance (Solo)
9:00a.m. (Auditorium)

Create From Waste
10:00a.m. (College Canteen)

Ragini - Hindustani Classical Solo Vocal
10:00a.m. (Music Room)

MathBola-The Mathematical Tambola
10:30a.m. (Room No. 14)

Anjali Rangoli & Mehendi Competition
10:30a.m. (Room No. 17 and 1st Floor Corridor)

Euphonic-Western Singing Music Competition
10:30a.m. (Seminar Hall)

Rock Concert
2:00 p.m. (Auditorium)
Exclusively for JDMC
10th January, 2019

ADITI
ADITI@HSHASMA

ADVERTISERS & SPONSORS

EVENTS PARTNER

HOST : Principal, JDMC

For Details and Registration Contact:
Staff Adviser
Dr. Jayanti B. Sahasr (9912011423), Dr. Sagu Jayant (9912011423)

Office bearers of the Students' Union

President Shubhangi Sethi 9834272969	Vice-President Muskan Sharma 8834332238	Gen. Secretary Neha Wadhwa 8130345470	Treasurer Muskan Puri 9842826627
--	---	---	--

ADITI@HSHASMA



Blakni
PRINCIPAL
KAMALA NEHRU COLLEGE
(University of Delhi)
August Kranti Marg
New Delhi-110049

KAMALA NEHRU COLLEGE
(University of Delhi)
NAAC Accredited with 'A' Grade
August Kranti Marg, New Delhi – 110049
Phone: 011-26494881, Telefax: 011-26495964
E-mail: kamla.nehru_du@hotmail.com



ESTD. 1964

कमला नेहरू कॉलेज
(दिल्ली विश्वविद्यालय)
रा. मू. एवं प्र. प. द्वारा 'ए' श्रेणी प्रत्यायित
अगस्त क्रांति मार्ग, नई दिल्ली – 110049
दूरभाष: 011-26494881, टेलीफैक्स: 011- 26495964
ई-मेल: kamla.nehru_du@hotmail.com

Zephyr- Western Music Society

GLOBAL
MUSIC
INSTITUTE

GMI Presents
Pitch, Please!

20 A Cappella
18 Competition

Friday 16 Mar
11:00 am
GMI Auditorium

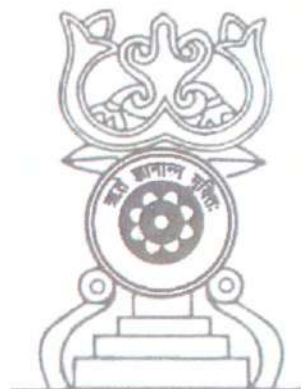

Kamala Nehru College
Estd. 1964

[Signature]
PRINCIPAL
KAMALA NEHRU COLLEGE
(University of Delhi)
August Kranti Marg
New Delhi-110049

KAMALA NEHRU COLLEGE
(University of Delhi)
NAAC Accredited with 'A' Grade
August Kranti Marg, New Delhi - 110049
Phone: 011-26494881, Telefax: 011-26495964
E-mail: kamla.nehru_du@hotmail.com



ESTD. 1964

कमला नेहरू कॉलेज
(दिल्ली विश्वविद्यालय)
रा. मू. एवं प्र. प. द्वारा 'ए' श्रेणी प्रत्यायित
अगस्त क्रांति मार्ग, नई दिल्ली - 110049
दूरभाष: 011-26494881, टेलीफैक्स: 011- 26495964
ई-मेल: kamla.nehru_du@hotmail.com

RESONANCE

THE WESTERN MUSIC SOCIETY
DYAL SINGH COLLEGE (H)

Bel Canto
(Solo Singing)

Pitch Slapped
(Acapella)

ONLINE REGISTRATIONS OPEN

DATE - 5TH MARCH
VENUE - AUDITORIUM
BEL CANTO SLOT DISTRIBUTION - 8AM - 9AM
PITCH SLAPPED SLOT DISTRIBUTION - 11AM - 12PM

CONTACT :
VIBHOR - 9540598405
AYUSH - 9582431833



Kamala Nehru College
Estd. 1964

PRINCIPAL
KAMALA NEHRU COLLEGE
(University of Delhi)
August Kranti Marg
New Delhi-110049

KAMALA NEHRU COLLEGE
(University of Delhi)
NAAC Accredited with 'A' Grade
August Kranti Marg, New Delhi – 110049
Phone: 011-26494881, Telefax: 011-26495964
E-mail: kamla.nehru_du@hotmail.com



ESTD. 1964

कमला नेहरू कॉलेज
(दिल्ली विश्वविद्यालय)
रा. मू. एवं प्र. प. द्वारा 'ए' श्रेणी प्रत्यायित
अगस्त क्रांति मार्ग, नई दिल्ली – 110049
दूरभाष: 011-26494881, टेलीफैक्स: 011- 26495964
ई-मेल: kamla.nehru_du@hotmail.com

GLOBAL
MUSIC
INSTITUTE

SECOND EDITION

PITCH, PLEASE!

inter-college
A Cappella Competition

SAT MAR 9 2019
GMI CAMPUS



Kamala Nehru College
Estd. 1964

PRINCIPAL
KAMALA NEHRU COLLEGE
(University of Delhi)
August Kranti Marg
New Delhi-110049

KAMALA NEHRU COLLEGE
(University of Delhi)
NAAC Accredited with 'A' Grade
August Kranti Marg, New Delhi - 110049
Phone: 011-26494881, Telefax: 011-26495964
E-mail: kamla.nehru_du@hotmail.com



ESTD. 1964

कमला नेहरू कॉलेज
(दिल्ली विश्वविद्यालय)
रा. मू. एवं प्र. प. द्वारा 'ए' श्रेणी प्रत्यापित
अगस्त क्रांति मार्ग, नई दिल्ली - 110049
दूरभाष: 011-26494881, टेलीफैक्स: 011- 26495964
ई-मेल: kamla.nehru_du@hotmail.com

**HOT
CHOCOLATE
FESTIVAL**

FEB 24, THE JUNCTION

MADHURIMA
THE MUSIC SOCIETY OF DTU

THE JUNCTION x EATTREAT LIVE



PRINCIPAL
KAMALA NEHRU COLLEGE
(University of Delhi)
August Kranti Marg
New Delhi-110049

KAMALA NEHRU COLLEGE
(University of Delhi)
NAAC Accredited with 'A' Grade
August Kranti Marg, New Delhi – 110049
Phone: 011-26494881, Telefax: 011-26495964
E-mail: kamla.nehru_du@hotmail.com



ESTD. 1964

कमला नेहरू कॉलेज
(दिल्ली विश्वविद्यालय)
रा. मू. एवं प्र. प. द्वारा 'ए' श्रेणी प्रत्यायित
अगस्त क्रांति मार्ग, नई दिल्ली – 110049
दूरभाष: 011-26494881, टेलीफैक्स: 011- 26495964
ई-मेल: kamla.nehru_du@hotmail.com

ORPHEUS

The Western Music Society of Miranda House
Presents

INTERLUDE "21"

The Annual Music Fest

LAST DATE OF
SUBMISSION FOR
ENTRIES:
1ST APRIL 2021

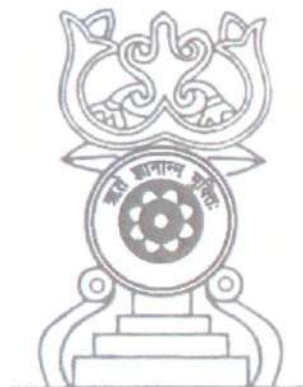

Kamala Nehru College
Estd. 1964



PRINCIPAL
KAMALA NEHRU COLLEGE
(University of Delhi)
August Kranti Marg
New Delhi-110049

KAMALA NEHRU COLLEGE
(University of Delhi)
NAAC Accredited with 'A' Grade
August Kranti Marg, New Delhi – 110049
Phone: 011-26494881, Telefax: 011-26495964
E-mail: kamla.nehru_du@hotmail.com

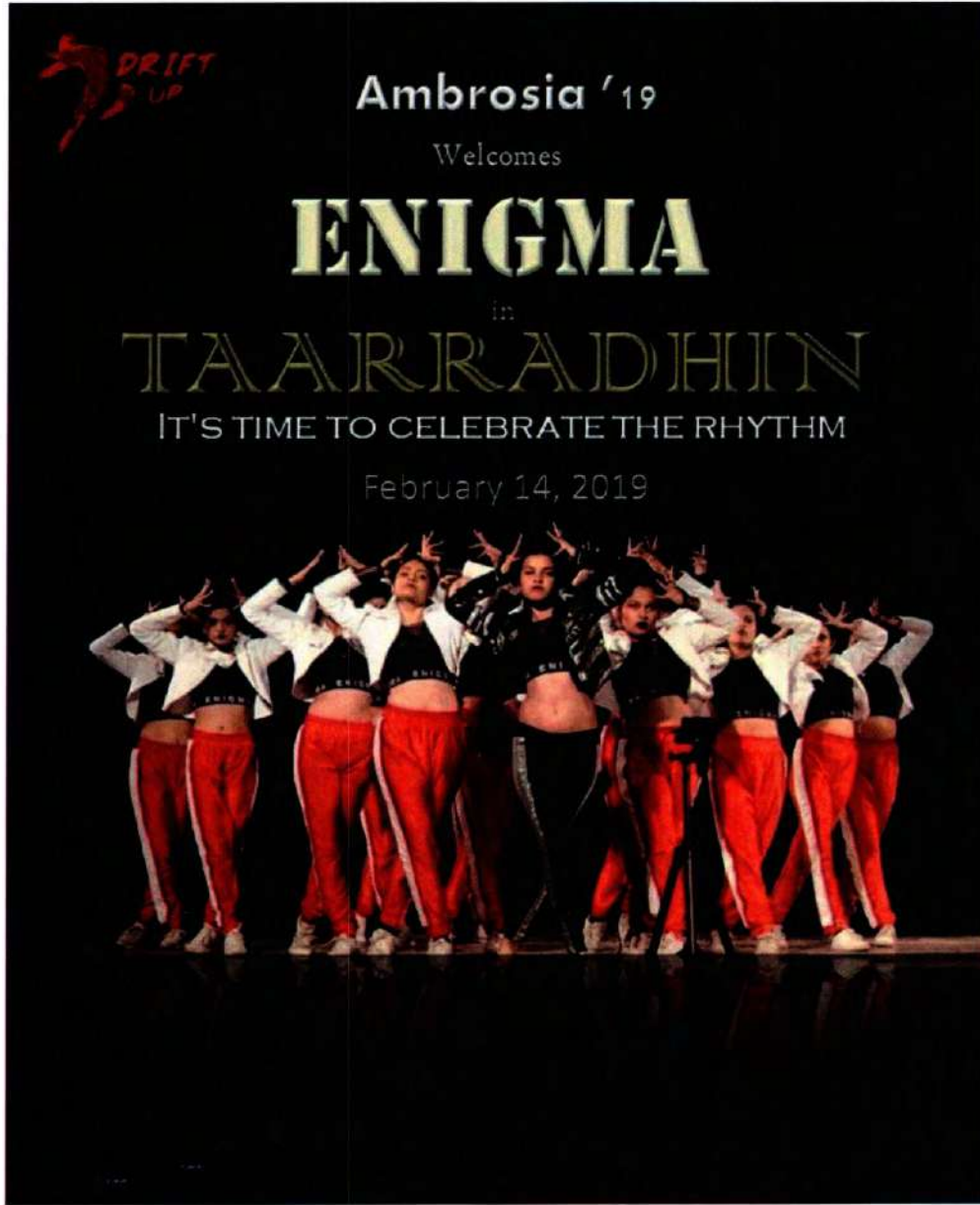

ESTD. 1964

कमला नेहरू कॉलेज
(दिल्ली विश्वविद्यालय)
रा. मू. एवं प्र. प. द्वारा 'ए' श्रेणी प्रत्यायित
अगस्त क्रांति मार्ग, नई दिल्ली – 110049
दूरभाष: 011-26494881, टेलीफैक्स: 011- 26495964
ई-मेल: kamla.nehru_du@hotmail.com



Kamala Nehru College
Estd. 1964

PRINCIPAL
KAMALA NEHRU COLLEGE
(University of Delhi)
August Kranti Marg
New Delhi-110049

KAMALA NEHRU COLLEGE
(University of Delhi)
NAAC Accredited with 'A' Grade
August Kranti Marg, New Delhi – 110049
Phone: 011-26494881, Telefax: 011-26495964
E-mail: kamla.nehru_du@hotmail.com



ESTD: 1964

कमला नेहरू कॉलेज
(दिल्ली विश्वविद्यालय)
रा. मू. एवं प्र. प. द्वारा 'ए' श्रेणी प्रत्यायित
अगस्त क्रांति मार्ग, नई दिल्ली – 110049
दूरभाष: 011-26494881, टेलीफैक्स: 011- 26495964
ई-मेल: kamla.nehru_du@hotmail.com

TOP SOCIETIES OF 2018-19

Top Western Dance Society

SPARDHA

The Western Dance Society
Shaheed Bhagat Singh College

DU beat



Kamala Nehru College
Estd. 1964

PRINCIPAL
KAMALA NEHRU COLLEGE
(University of Delhi)
August Kranti Marg
New Delhi-110049

KAMALA NEHRU COLLEGE
(University of Delhi)
NAAC Accredited with 'A' Grade
August Kranti Marg, New Delhi – 110049
Phone: 011-26494881, Telefax: 011-26495964
E-mail: kamla.nehru_du@hotmail.com



कमला नेहरू कॉलेज
(दिल्ली विश्वविद्यालय)
रा. मू. एवं प्र. प. द्वारा 'ए' श्रेणी प्रत्यायित
अगस्त क्रांति मार्ग, नई दिल्ली – 110049
दूरभाष: 011-26494881, टेलीफैक्स: 011- 26495964
ई-मेल: kamla.nehru_du@hotmail.com

LAKSHYA DRAMATICS SOCIETY OF KNC

LSR DRAMATICS SOCIETY

PRESENTS

YAVNIKA | NUKKAD



TARANG 2019
1ST | 2ND | 3RD FEBRUARY

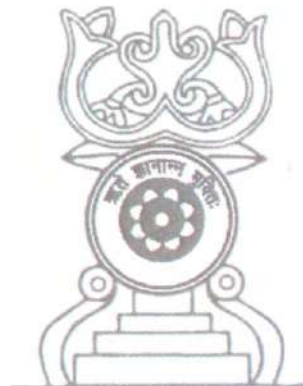

Kamala Nehru College
Estd. 1964

PRINCIPAL
KAMALA NEHRU COLLEGE
(University of Delhi)
August Kranti Marg
New Delhi-110049

KAMALA NEHRU COLLEGE
 (University of Delhi)
 AAC Accredited with 'A' Grade
 August Kranti Marg, New Delhi - 110049
 Phone: 011-26494881, Telefax: 011-26495964
 E-mail: kamla.nehru_du@hotmail.com



Estd.1964

कमला नेहरू कॉलेज
 (दिल्ली विश्वविद्यालय)
 रा. मू. एवं प्र. प. द्वारा 'ए' श्रेणी प्रत्यापित
 अगस्त क्रांति मार्ग, नई दिल्ली - 110049
 दूरभाष: 011-26494881, टेलीफैक्स: 011- 26495964
 ई-मेल: kamla.nehru_du@hotmail.com

NUPUR-Dance Society

**NUPUR DANCE SOCIETY
 KAMALA NEHRU COLLEGE**

**INVITES YOU
 TO THE**

ORIENTATION SESSION 2021-22

Date- 25th November 2021
 Platform- Google Meet
 Time- 12pm - 1pm

[Handwritten Signature]
PRINCIPAL
KAMALA NEHRU COLLEGE
 (University of Delhi)
 August Kranti Marg
 New Delhi-110049

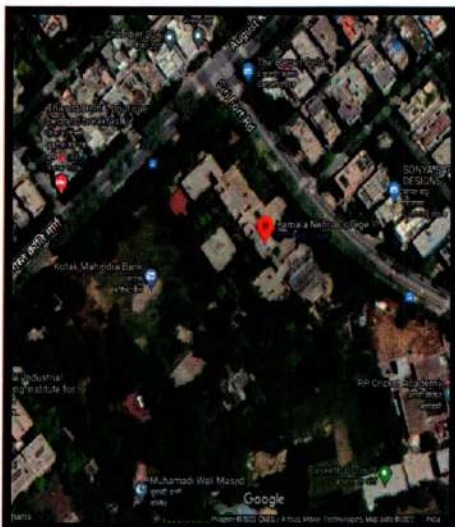

Kamala Nehru College
 Estd. 1964

Kamala Nehru College .jpg Properties

Property	Value
Saturation	
Sharpness	
White balance	Auto
Photometric interpretation	
Digital zoom	
EXIF version	0232
GPS	
Latitude	28.33.22.42999999999920667
Longitude	77.13.0.8800000000004699
Altitude	226.30173884273895
File	
Name	Kamala Nehru College .jpg
Item type	JPG File
Folder path	C:\Users\josepi\Downloads
Date created	23-03-2022 10:17 PM
Date modified	23-03-2022 10:17 PM
Size	1.50 MB
Attributes	A
Availability	

[Remove Properties and Personal Information](#)

OK Cancel Apply

KAMALA NEHRU COLLEGE
 (University of Delhi)
 AAC Accredited with 'A' Grade
 August Kranti Marg, New Delhi – 110049
 Phone: 011-26494881, Telefax: 011-26495964
 E-mail: kamla.nehru_du@hotmail.com



Estd.1964

कमला नेहरू कॉलेज
 (दिल्ली विश्वविद्यालय)
 रा. मू. एवं प्र. प. द्वारा 'ए' श्रेणी प्रत्यायित
 अगस्त क्रांति मार्ग, नई दिल्ली – 110049
 दूरभाष: 011-26494881, टेलीफैक्स: 011- 26495964
 ई-मेल: kamla.nehru_du@hotmail.com

Nupur
2021-22

AUDITIONS

26th nov- 6th dec 2021

*For any queries please contact us on:
 Email: kncnupur@gmail.com
 Insta: nupurdancesociety_knc*

[Signature]
PRINCIPAL
KAMALA NEHRU COLLEGE
 (University of Delhi)
 August Kranti Marg
 New Delhi-110049



Kamala Nehru College .jpg Properties

Property	Value
Saturation	
Sharpness	
White balance	Auto
Photometric interpretation	
Digital zoom	
EXIF version	0232
GPS	
Latitude	28, 33, 22, 42999099999929857
Longitude	77, 13, 0, 880000000004699...
Altitude	226, 30173864273695
File	
Name	Kamala Nehru College .jpg
Item type	JPG File
Folder path	C:\Users\joseph\Downloads
Date created	23-03-2022 10:17 PM
Date modified	23-03-2022 10:17 PM
Size	1.50 MB
Attributes	A
Availability	

[Remove Properties and Personal Information](#)

OK Cancel Apply

KAMALA NEHRU COLLEGE
University of Delhi)
IAAC Accredited with 'A' Grade
August Kranti Marg, New Delhi – 110049
Phone: 011-26494881, Telefax: 011-26495964
E-mail: kamla.nehru_du@hotmail.com



Estd.1964

कमला नेहरू कॉलेज
(दिल्ली विश्वविद्यालय)
रा. मू. एवं प्र. प. द्वारा 'ए' श्रेणी प्रत्यायित
अगस्त क्रांति मार्ग, नई दिल्ली – 110049
दूरभाष: 011-26494881, टेलीफैक्स: 011- 26495964
ई-मेल: kamla.nehru_du@hotmail.com

NUPUR
The Indian Classical and Folk Dance Society
of
Kamala Nehru College
presents



"Odissi: The Aesthetics"
with
Guru Madhumita Raut
Date: 14th Sept, 2016
Time: 10:30 a.m.
Venue: Auditorium

For queries, contact:

Dr. Sushma Choudhary
8586817893
(Teacher convener)

Shreya Banerjee
8588003622
Trishya Verma
8447680509
(Student Conveners)

Principal
PRINCIPAL
KAMALA NEHRU COLLEGE
(University of Delhi)
August Kranti Marg
New Delhi-110049

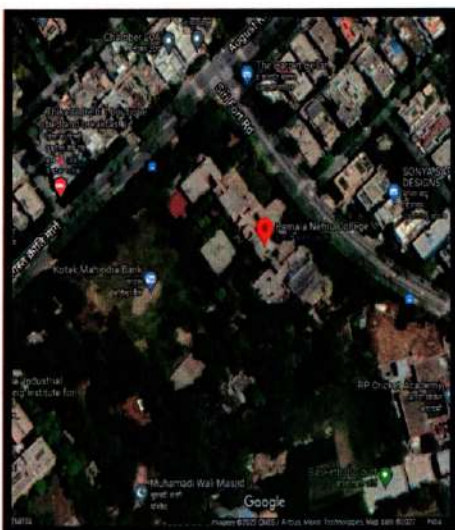

Kamala Nehru College
Estd. 1964

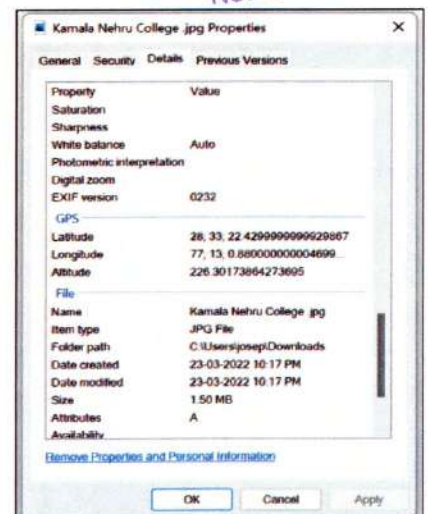



Estd.1964

Kaleidoscope- Quiz Society

THE QUIZZING SOCIETIES OF DELHI UNIVERSITY PRESENT

QUIZ FOR A CAUSE

11 JULY: INDIA QUIZ

12 JULY: GENERAL QUIZ

TIMING- 2.30PM

FUNDRAISER QUIZZES FOR FOOD DISTRIBUTION (COVID RELIEF)

PROCEEDS WILL GO TO THE SHEROES HANGOUT FOUNDATION

Shivam Sanoria
 Quizmasters

Akshay Seal

[Signature]
PRINCIPAL
 KAMALA NEHRU COLLEGE
 (University of Delhi)
 August Kranti Marg
 New Delhi-110049

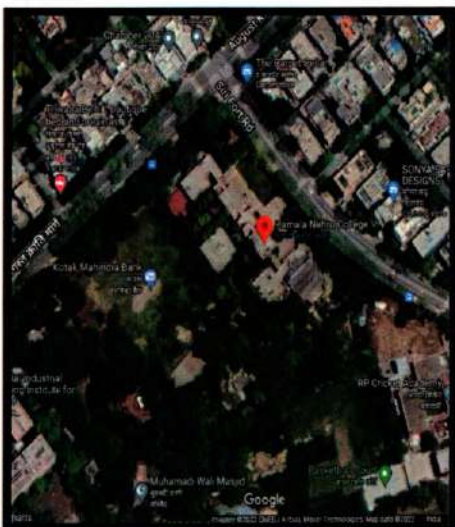

Kamala Nehru College .jpg Properties

Property	Value
Saturation	
Sharpness	
White balance	Auto
Photometric interpretation	
Digital zoom	
EXIF version	0232
GPS	
Latitude	28.33.22.429999999999929087
Longitude	77.13.0.8880000000004699.
Altitude	226.30173864273685
File	
Name	Kamala Nehru College .jpg
Item type	JPG File
Folder path	C:\Users\jowep\Downloads
Date created	23-03-2022 10:17 PM
Date modified	23-03-2022 10:17 PM
Size	1.50 MB
Attributes	A
Availability	

Remove Properties and Personal Information

OK Cancel Apply

KAMALA NEHRU COLLEGE
 (University of Delhi)
 AAC Accredited with 'A' Grade
 August Kranti Marg, New Delhi – 110049
 Phone: 011-26494881, Telefax: 011-26495964
 E-mail: kamla.nehru_du@hotmail.com



Estd.1964

कमला नेहरू कॉलेज
 (दिल्ली विश्वविद्यालय)
 रा. मू. एवं प्र. प. द्वारा 'ए' श्रेणी प्रत्यायित
 अगस्त क्रांति मार्ग, नई दिल्ली – 110049
 दूरभाष: 011-26494881, टेलीफैक्स: 011- 26495964
 ई-मेल: kamla.nehru_du@hotmail.com

Kaleidoscope Quiz Society
 Kamala Nehru College
 University of Delhi
 Presents

EVERYTHING UNDER THE SUN!
 Inter-College General Quiz
 as part of the Annual Quiz Fest

QURUKSHETRA

Prelims - 16th April, 1 pm
 Finals - 18th April, 5 pm

Teams of 2/lonewolves
 Platform D2C + G-MEET.

Win Cash prizes worth Rs.6000
 Register now!!

[Signature]
 PRINCIPAL
 KAMALA NEHRU COLLEGE
 (University of Delhi)
 August Kranti Marg
 New Delhi-110049

Qurukshetra 2018

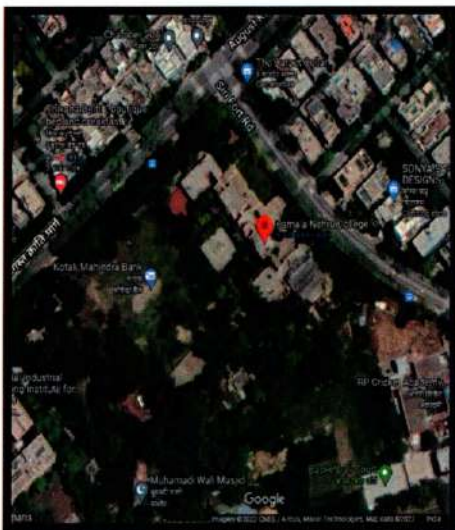

Kamala Nehru College .jpg Properties

Property	Value
Saturation	
Sharpness	
White balance	Auto
Photometric interpretation	
Digital zoom	
EXIF version	0232
GPS	
Latitude	28, 33, 22 4299999999920867
Longitude	77, 13, 0.8800000000004699
Altitude	226.30173864273695
File	
Name	Kamala Nehru College .jpg
Item type	JPG File
Folder path	C:\Users\josep\Downloads
Date created	23-03-2022 10:17 PM
Date modified	23-03-2022 10:17 PM
Size	1.50 MB
Attributes	A
Availability	

Remove Properties and Personal Information

OK Cancel Apply

KAMALA NEHRU COLLEGE
 University of Delhi)
 AAC Accredited with 'A' Grade
 August Kranti Marg, New Delhi - 110049
 Phone: 011-26494881, Telefax: 011-26495964
 E-mail: kamla.nehru_du@hotmail.com



Estd.1964

कमला नेहरू कॉलेज
 (दिल्ली विश्वविद्यालय)
 रा. मू. एवं प्र. प. द्वारा 'ए' श्रेणी प्रत्यापित
 अगस्त क्रांति मार्ग, नई दिल्ली - 110049
 दूरभाष: 011-26494881, टेलीफैक्स: 011- 26495964
 ई-मेल: kamla.nehru_du@hotmail.com



KALEIDOSCOPE

QUIZ SOCIETY OF
KAMALA NEHRU COLLEGE
invites you to

INSTAGRAM LIVE

ICONIC DUOS/COUPLES QUIZ

VENUE-KALEIDOSCOPE_KNC
DATE-14 FEB,2021
TIME- 9:00PM

FOR QUERIES
 DM:KALEIDOSCOPE_KNC OR
 MAIL: KNC.KALEIDOSCOPE@GMAIL.COM

STAY TUNED

(Signature)
 PRINCIPAL
 KAMALA NEHRU COLLEGE
 (University of Delhi)
 August Kranti Marg
 New Delhi-110049



Kamala Nehru College .jpg Properties

Property	Value
Saturation	
Sharpness	
White balance	Auto
Photometric interpretation	
Digital zoom	
EXIF version	0232
GPS	
Latitude	28.33.22.42999999999992867
Longitude	77.13.0.8800000000004699
Altitude	226.30173864273685
File	
Name	Kamala Nehru College .jpg
Item type	JPG File
Folder path	C:\Users\josep\Downloads
Date created	23-03-2022 10:17 PM
Date modified	23-03-2022 10:17 PM
Size	1.50 MB
Attributes	A
Availability	

Remove Properties and Personal Information

OK Cancel Apply



Estd.1964



KALEIDOSCOPE

The Quiz Society of
KAMALA NEHRU COLLEGE
invites you to the
INTRA-COLLEGE QUIZ

JASHN-e-HINDUSTAN

The India Quiz

27 January, Wednesday
1:00 - 2:30 PM
Cash prize worth Rs.1000
Platform: Google Meet

**Celebrating India in the
best way we know!**

For queries, DM on:
[@kaleidoscope_knc](#)

PRINCIPAL
KAMALA NEHRU COLLEGE
(University of Delhi)
August Kranti Marg
New Delhi-110049

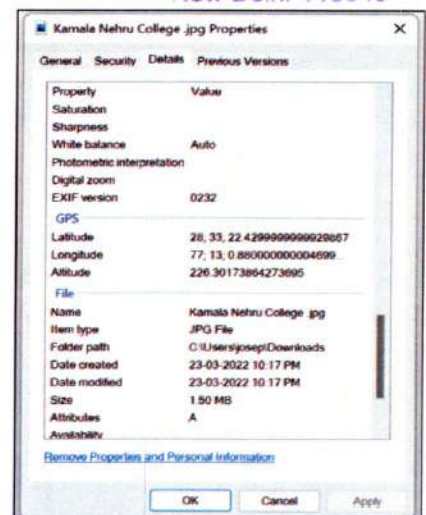
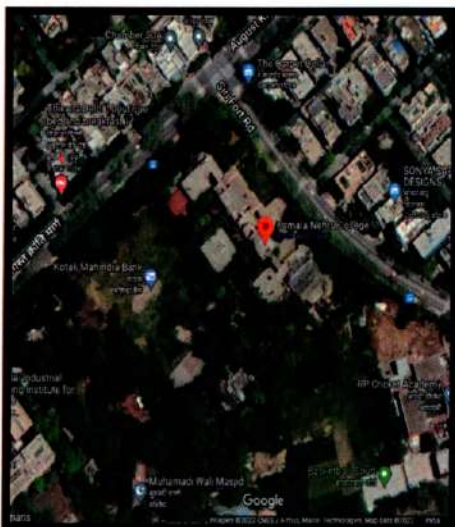

KAMALA NEHRU COLLEGE
 (University of Delhi)
 AAC Accredited with 'A' Grade
 August Kranti Marg, New Delhi - 110049
 Phone: 011-26494881, Telefax: 011-26495964
 E-mail: kamla.nehru_du@hotmail.com



Estd. 1964

कमला नेहरू कॉलेज
 (दिल्ली विश्वविद्यालय)
 रा. मू. एवं प्र. प. द्वारा 'ए' श्रेणी प्रत्यापित
 अगस्त क्रांति मार्ग, नई दिल्ली - 110049
 दूरभाष: 011-26494881, टेलीफैक्स: 011- 26495964
 ई-मेल: kamla.nehru_du@hotmail.com

**KALEIDOSCOPE
 QUIZ SOCIETY
 KAMALA NEHRU COLLEGE
 UNIVERSITY OF DELHI
 PRESENTS**

HOLE IN THE DONUT!
INTRA COLLEGE MUSIC, TRAVEL and FOOD QUIZ
AS PART OF THE ANNUAL QUIZ FEST

QURUक्षेत्र

PRELIMS- 16 APRIL, 5 PM
 FINALS- 17 APRIL, 5PM

Teams of 2/lonewolves
 PLATFORM- D2C+GMEET

WIN CASH PRIZES WORTH RS 1500

REGISTER NOW

K. Blalok
PRINCIPAL
KAMALA NEHRU COLLEGE
 (University of Delhi)
 August Kranti Marg
 New Delhi-110049

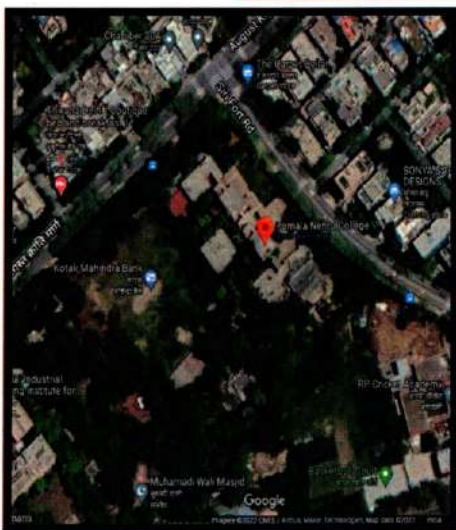

Kamala Nehru College .jpg Properties

Property	Value
Saturation	
Sharpness	
White balance	Auto
Photometric interpretation	
Digital zoom	
EXIF version	0232
GPS	
Latitude	28.33.22.4299999999920667
Longitude	77.13.0.880000000004699
Altitude	226.30173864273605
File	
Name	Kamala Nehru College .jpg
Item type	JPG File
Folder path	C:\Users\josep\Downloads
Date created	23-03-2022 10:17 PM
Date modified	23-03-2022 10:17 PM
Size	1.50 MB
Attributes	A
Availability	

Remove Properties and Personal Information

OK Cancel Apply



Estd.1964

Abhivaykti- Hindi Debating Society

हिंदी वाद-विवाद समिति
कमला नेहरू कॉलेज

अभिव्यक्ति

प्रस्तुत करती है

आशुभाषण प्रतियोगिता

दिनांक: 13, मार्च 2019

PRINCIPAL
KAMALA NEHRU COLLEGE
(University of Delhi)
August Kranti Marg
New Delhi-110049

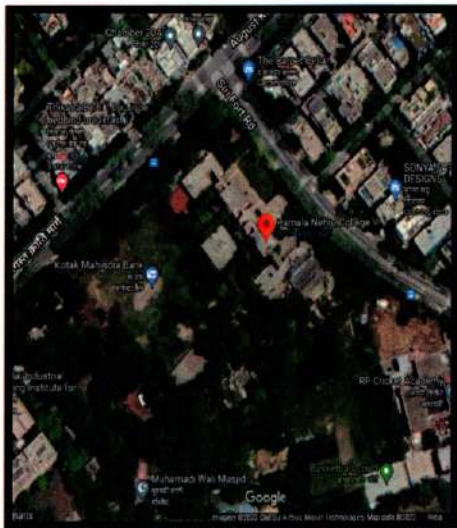

Kamala Nehru College
Estd. 1964

Kamala Nehru College .jpg Properties

Property	Value
Saturation	
Sharpness	
White balance	Auto
Photometric interpretation	
Digital zoom	
EXIF version	0232
GPS	
Latitude	28, 33, 22.429999999999928857
Longitude	77, 13, 0.88000000000004899...
Altitude	226.30173864273695
File	
Name	Kamala Nehru College .jpg
Item type	JPG File
Folder path	C:\Users\josep\Downloads
Date created	23-03-2022 10:17 PM
Date modified	23-03-2022 10:17 PM
Size	1.50 MB
Attributes	A
Availability	

Remove Properties and Personal Information

OK Cancel Apply



 **कमला नेहरू कॉलेज**
'अभिव्यक्ति'
हिंदी वाद- विवाद समिति

दिनांक: 13, मार्च, 2019
समय: 10:30 बजे प्रातः
स्थान: L-102

अंतर्महाविद्यालय आशुभाषण प्रतियोगिता

नियम:

- _ विषय उसी समय दिया जाएगा।
- _ प्रत्येक प्रतिभागी को 2+1 का समय दिया जाएगा।
- _ प्रत्येक कॉलेज से दो प्रतिभागी ही मान्य हैं।
- _ पहले आओ, पहले पाओ नीति का पालन होगा।
- _ सभी प्रतिभागियों के लिए अपने कॉलेज का पहचान पत्र लाना अनिवार्य है।
- _ निर्णायक मंडल का निर्णय अंतिम व सर्वमान्य है।
- _ पंजीकरण का समय प्रातः 9:00-10:00 बजे तक है।
- _ नियम परिवर्तन का अधिकार आयोजकों के पास सुरक्षित है।

संयोजिका:
डॉ रजत रानी आर्य-9911043588
छात्रा संयोजिका:
रितिका भटनागर-7210199874

PRINCIPAL
KAMALA NEHRU COLLEGE
(University of Delhi)
August Kranti Marg
New Delhi-110049

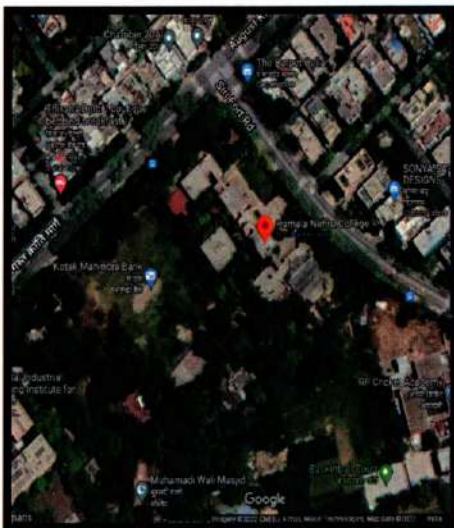



अभिव्यक्ति
हिंदी वाद- विवाद समिति
Hindi Debating Society

हिंदी वाद- विवाद समिति अभिव्यक्ति की ओर से कमला नेहरू महाविद्यालय की छात्राओं के लिए हिंदी वाद- विवाद प्रतियोगिता का आयोजन किया जा रहा है। यह प्रतियोगिता दो चरणों में आयोजित होगी। प्रथम चरण प्रथम वर्ष की नवगात छात्राओं के लिए प्रतियोगिता होगी। दूसरे चरण में अंतर्कक्षा छात्राओं के लिए प्रतियोगिता होगी। इस प्रतियोगिता में जो छात्राएं हिस्सा लेना चाहती हैं वह अपना नाम निम्नलिखित सदस्यों को 2 सितंबर 2019 तक आविष्य दें।

विषय: 'सोशल मीडिया मुख्य मीडिया का सशक्त विकल्प है'

दिनांक: 4 सितंबर, बुधवार 2019
समय: 12:40- 2:50 (ECA Break)
स्थान: कॉमन रूम

नोट: प्रत्येक वक्ता को 3+1 का समय दिया जाएगा। केवल विषय के पक्ष में या विपक्ष में अपने विचार प्रस्तुत करने की अनुमति होगी। निर्णयाकों निर्णय अंतिम और सर्वमान्य होगा।

सायोजिका डॉ रजत रानी आर्य 9911043588	छात्रा सायोजिका सोफिया अली 9891799332	छात्रा उप सायोजिका हर्षिता मिश्रा 7352243563
--	---	--

PRINCIPAL
KAMALA NEHRU COLLEGE
(University of Delhi)
August Kranti Marg
New Delhi-110049

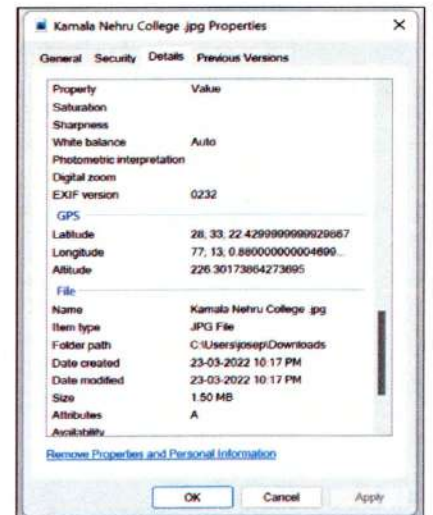
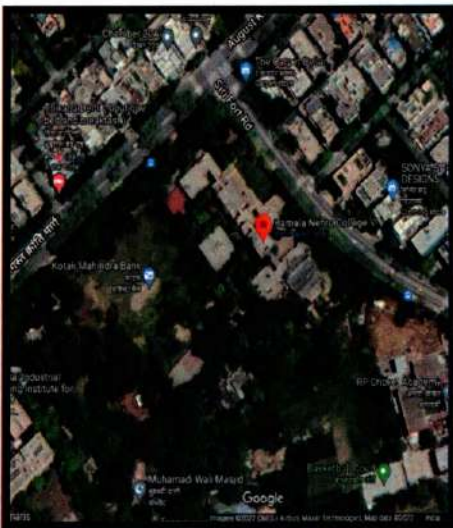

KAMALA NEHRU COLLEGE
University of Delhi)
AAC Accredited with 'A' Grade
August Kranti Marg, New Delhi – 110049
Phone: 011-26494881, Telefax: 011-26495964
E-mail: kamla.nehru_du@hotmail.com



Estd.1964

कमला नेहरू कॉलेज
(दिल्ली विश्वविद्यालय)
रा. मू. एवं प्र. प. द्वारा 'ए' श्रेणी प्रत्यापित
अगस्त क्रांति मार्ग, नई दिल्ली – 110049
दूरभाष: 011-26494881, टेलीफैक्स: 011- 26495964
ई-मेल: kamla.nehru_du@hotmail.com

कमला नेहरू कॉलेज, दिल्ली विश्वविद्यालय
वाद- विवाद समिति

अभिव्यक्ति

प्रस्तुत करती है अपनी पहली
अन्तर कॉलेज प्रतियोगिता

"मुखर"

वाद- विवाद + टर्नकोट प्रतियोगिता
19 March 2020
9:00 am

संयोजिका
डॉ रजत रानी आर्य:9911043588

छात्रा संयोजिका
सोफिया अली:9891799332

छात्रा उप संयोजिका
हर्षिता मिश्रा:7352243563

अन्य जानकारी के लिए :
Abhivyakti- Hindi Debating Society Instagram:knc.abhivyakti
Facebook: Abhivyakti- Hindi Debating Society

PRINCIPAL
KAMALA NEHRU COLLEGE
(University of Delhi)
August Kranti Marg
New Delhi-110049



Kamala Nehru College
Estd. 1964

Kamala Nehru College .jpg Properties

Property	Value
Saturation	
Sharpness	
White balance	Auto
Photometric interpretation	
Digital zoom	
EXIF version	0232
GPS	
Latitude	28, 33, 22.429999999999928857
Longitude	77, 13, 0.88000000000004699
Altitude	226.30173864273695
File	
Name	Kamala Nehru College .jpg
Item type	JPG File
Folder path	C:\Users\josep\Downloads
Date created	23-03-2022 10:17 PM
Date modified	23-03-2022 10:17 PM
Size	1.50 MB
Attributes	A
Availability	

Remove Properties and Personal Information

OK Cancel Apply



Estd.1964

कमला नेहरू कॉलेज, दिल्ली विश्वविद्यालय

हिन्दी वाद-विवाद समिति

अभिव्यक्ति

प्रस्तुत करती है अन्तर्महाविद्यालय हिन्दी वाद-विवाद वेब प्रतियोगिता

'मुखर' 2020

प्रतियोगिता का विषय है

'कोरोना से बचाव का एकमात्र उपाय केवल लाकडाउन ही है।'

दिनांक - 20 जून, 2020

समय - 3:00PM -6:00PM

प्लेटफॉर्म - SKYPE APP

प्राचार्या - डॉ कल्पना भाकुनी अधिक जानकारी हेतु सम्पर्क करें

संयोजिका : डॉ रजत रानी आर्य मानवी -9896796869

छात्रा संयोजिका - सोफिया अली विदूषी - 9756975384

विजेताओं को प्रथम, द्वितीय, तृतीय एवं दो सांत्वना पुरस्कार दिये जायेंगे।

साथ ही साथ सभी प्रतिभागियों को भागीदारी का ई-प्रमाण पत्र दिया जाएगा।

Sp Adobe Spark

PRINCIPAL
KAMALA NEHRU COLLEGE
(University of Delhi)
August Kranti Marg
New Delhi-110049

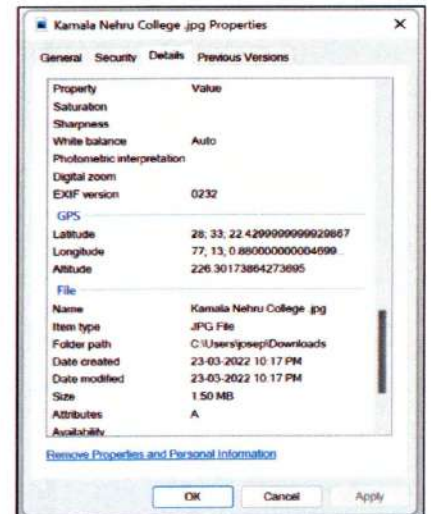
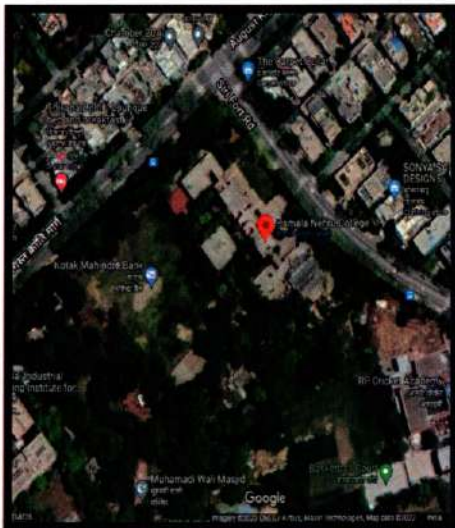



Estd.1964



कमला नेहरू कॉलेज

दिल्ली विश्वविद्यालय
तथा
जवाहरलाल नेहरू राजकीय महाविद्यालय, पोर्ट ब्लेयर
पाँडिचेरी विश्वविद्यालय

विद्या विस्तार योजना के अंतर्गत

वेबिनार एवं विचार संगम प्रतियोगिता

विशिष्ट अतिथि - विजय बहादुर सिंह, भोपाल
वक्ता - डॉ. दुर्गा प्रसाद गुप्त, दिल्ली

वेबिनार का विषय: "राष्ट्रीय सांस्कृतिक कार्यधारा में राष्ट्रीयता का स्वप्न"



डॉ. हेमंत कुमार शर्मा
प्राचार्य
जवाहरलाल नेहरू राजकीय महाविद्यालय
पोर्ट ब्लेयर

डॉ. आर. वी. आर. मूर्ती
संयोजक, विद्या विस्तार योजना

डॉ. भारती
प्रभारी, हिन्दी विभाग
कमला नेहरू कॉलेज

विचार संगम प्रतियोगिता का विषय:
"हर मन का उत्सव है 'आजादी का अमृत महात्सव'।"

समय - प्रातः 10:30 - दोपहर 01:00
22 दिसंबर 2021

गूगल मीट लिंक - <https://meet.google.com/jyi-nyyz-szt>

प्रो. कल्पना भाकुनी
प्राचार्या
कमला नेहरू कॉलेज

डॉ. रंजना ए. मेरा
संयोजिका, विद्या विस्तार योजना

डॉ. सीमा महेश्वरी
संयोजिका, 'अभिव्यक्ति'
कमला नेहरू कॉलेज

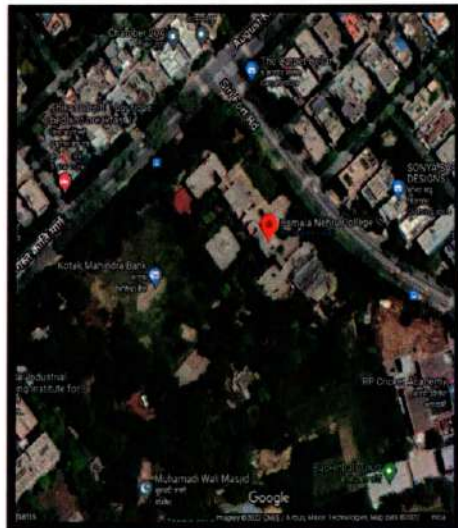

Kamala Nehru College
Estd. 1964



PRINCIPAL
KAMALA NEHRU COLLEGE
(University of Delhi)
August Kranti Marg
New Delhi-110049



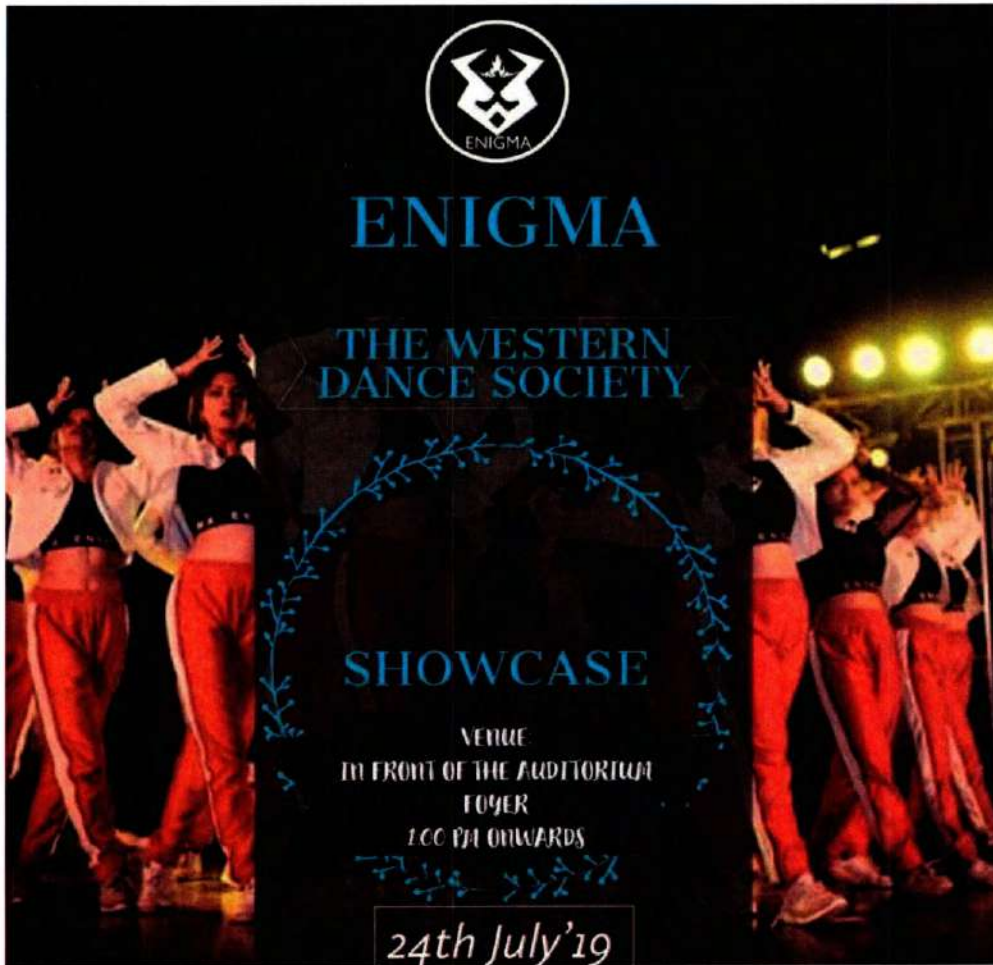

Estd.1964

Enigma-Western Dance Society



K. Bhatnagar
 PRINCIPAL
 KAMALA NEHRU COLLEGE
 (University of Delhi)
 August Kranti Marg
 New Delhi-110049

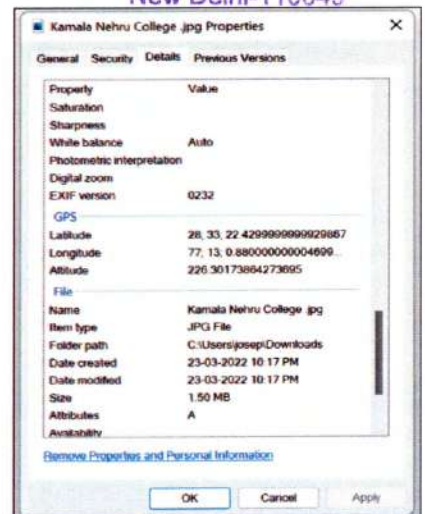
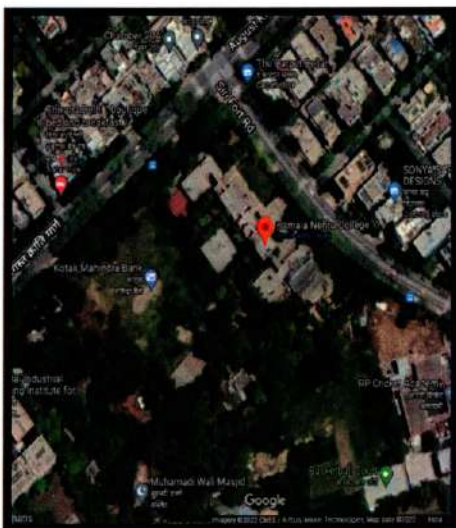

KAMALA NEHRU COLLEGE
 University of Delhi)
 AAC Accredited with 'A' Grade
 August Kranti Marg, New Delhi - 110049
 Phone: 011-26494881, Telefax: 011-26495964
 E-mail: kamla.nehru_du@hotmail.com



Estd.1964

कमला नेहरू कॉलेज
 (दिल्ली विश्वविद्यालय)
 रा. मू. एवं प्र. प. द्वारा 'ए' श्रेणी प्रत्यापित
 अगस्त क्रांति मार्ग, नई दिल्ली - 110049
 दूरभाष: 011-26494881, टेलीफैक्स: 011- 26495964
 ई-मेल: kamla.nehru_du@hotmail.com

Lakshya- Theatre Society

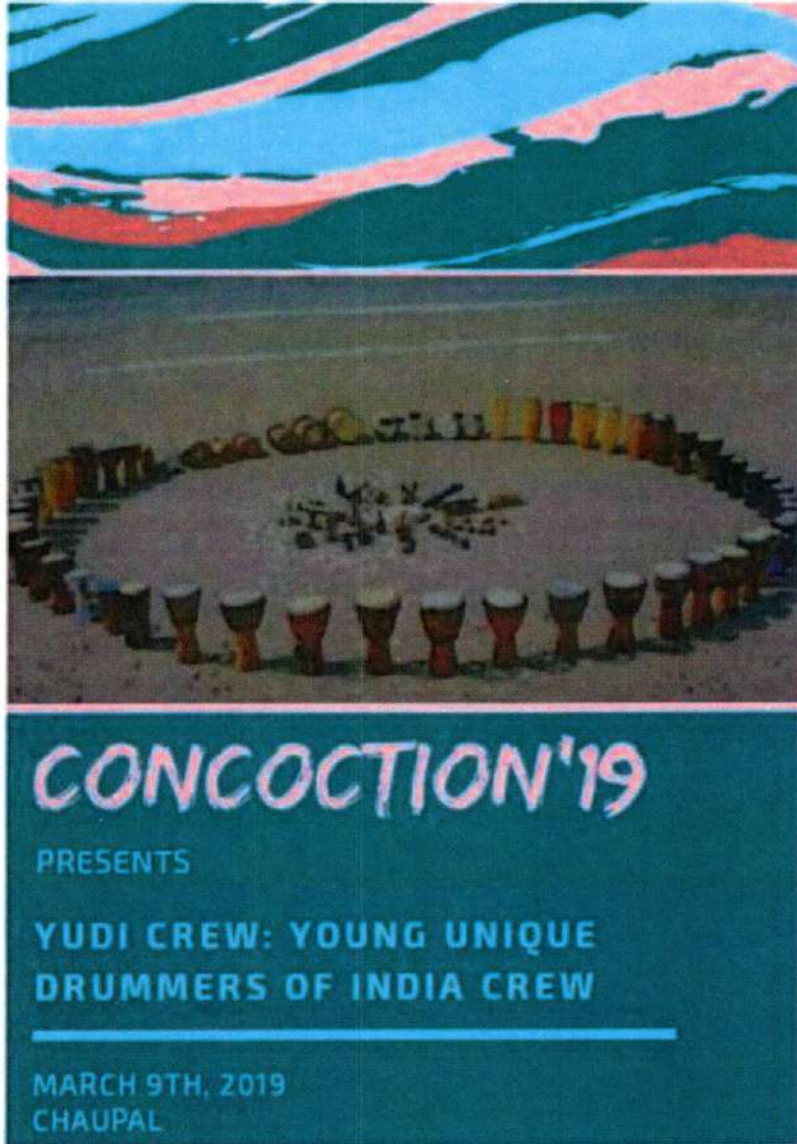

[Signature]
 PRINCIPAL
 KAMALA NEHRU COLLEGE
 (University of Delhi)
 August Kranti Marg
 New Delhi-110049

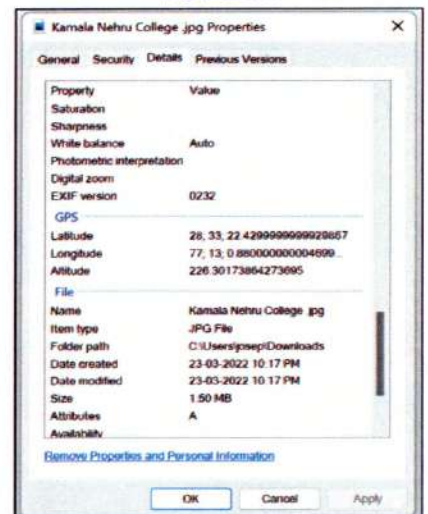
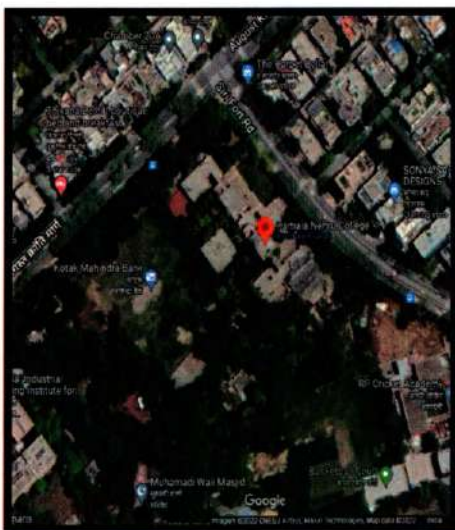

KAMALA NEHRU COLLEGE
 (University of Delhi)
 AAC Accredited with 'A' Grade
 August Kranti Marg, New Delhi - 110049
 Phone: 011-26494881, Telefax: 011-26495964
 E-mail: kamla.nehru_du@hotmail.com



Estd. 1964

कमला नेहरू कॉलेज
 (दिल्ली विश्वविद्यालय)
 रा. मू. एवं प्र. प. द्वारा 'ए' श्रेणी प्रत्यापित
 अगस्त क्रांति मार्ग, नई दिल्ली - 110049
 दूरभाष: 011-26494881, टेलीफैक्स: 011- 26495964
 ई-मेल: kamla.nehru_du@hotmail.com

लक्ष्म

THE THEATRE SOCIETY OF
 KAMALA NEHRU COLLEGE

Presents

KAR-RAGE

26th July '19
 1:00 pm
 Champak

FOR MORE QUERIES CONTACT US

AASTHA MUTREJA 8130140603
 AMRIT KAUR 9953253809
 SANJANA SACHDEVA 9416081378

PRINCIPAL
 KAMALA NEHRU COLLEGE
 (University of Delhi)
 August Kranti Marg
 New Delhi-110049

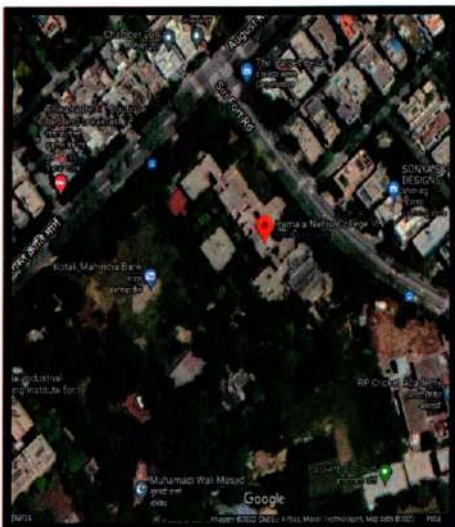

Kamala Nehru College .jpg Properties

Property	Value
Saturation	
Sharpness	
White balance	Auto
Photometric interpretation	
Digital zoom	
EXIF version	0232
GPS	
Latitude	28, 33, 22.429999999999929867
Longitude	77, 13, 0.88000000000004699
Altitude	226.30173864273695
File	
Name	Kamala Nehru College .jpg
Item type	JPG File
Folder path	C:\Users\josep\Downloads
Date created	23-03-2022 10:17 PM
Date modified	23-03-2022 10:17 PM
Size	1.50 MB
Attributes	A
Availability	

Remove Properties and Personal Information

OK Cancel Apply

KAMALA NEHRU COLLEGE
 University of Delhi)
 AAC Accredited with 'A' Grade
 August Kranti Marg, New Delhi – 110049
 Phone: 011-26494881, Telefax: 011-26495964
 E-mail: kamla.nehru_du@hotmail.com



Estd.1964

कमला नेहरू कॉलेज
 (दिल्ली विश्वविद्यालय)
 रा. मू. एवं प्र. प. द्वारा 'ए' श्रेणी प्रत्यापित
 अगस्त क्रांति मार्ग, नई दिल्ली – 110049
 दूरभाष: 011-26494881, टेलीफैक्स: 011- 26495964
 ई-मेल: kamla.nehru_du@hotmail.com



लक्ष्म

THE THEATRE SOCIETY OF KAMALA NEHRU COLLEGE

AUDITIONS

*Actors, Writers, Singers, Instrumentalists
 All are welcome!*

30th July 19 - 31st July 19 || 9:30 am Onwards || Chaupal

PRINCIPAL
 KAMALA NEHRU COLLEGE
 (University of Delhi)
 August Kranti Marg
 New Delhi 110049

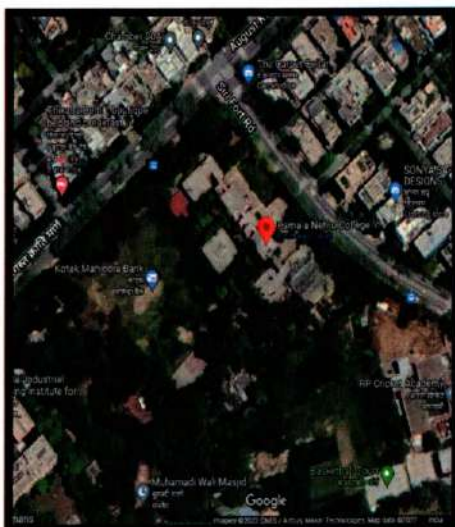

Kamala Nehru College
 Estd. 1964

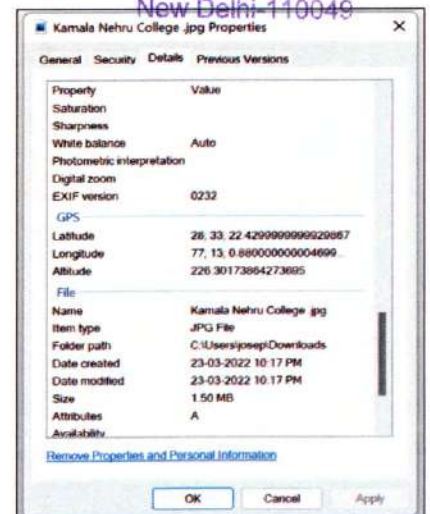



Estd.1964

OPEN MIC | लक्ष्य

CELEBRATING 'AZADI KA AMRIT MAHOTSAV

THEME-
21st CENTURY WOMEN

18th AUGUST, 2021 | **TIME LIMIT: 2 Minutes**

TIMINGS | 5:00-6:30pm | **DEADLINE: 16th AUGUST, 2021 (MIDNIGHT)**

VENUE: GOOGLE MEET

ONLY FOR KNC STUDENTS

Blak
PRINCIPAL
KAMALA NEHRU COLLEGE
(University of Delhi)
August Kranti Marg
New Delhi-110049



KAMALA NEHRU COLLEGE
 University of Delhi)
 AAC Accredited with 'A' Grade
 August Kranti Marg, New Delhi – 110049
 Phone: 011-26494881, Telefax: 011-26495964
 E-mail: kamla.nehru_du@hotmail.com



Estd.1964

कमला नेहरू कॉलेज
 (दिल्ली विश्वविद्यालय)
 रा. मू. एवं प्र. प. द्वारा 'ए' श्रेणी प्रत्यापित
 अगस्त क्रांति मार्ग, नई दिल्ली – 110049
 दूरभाष: 011-26494881, टेलीफैक्स: 011- 26495964
 ई-मेल: kamla.nehru_du@hotmail.com

